

Buggy Service Manual

MAXXAM
150 2R



ACE
SPORTS

239 County Road 4435
Brundidge, AL 36081
www.acesportsonline.com
P: 1-888-562-9ACE
F: 1-888-562-8ACE

FOREWORD

This service manual has been specially prepared to provide all the necessary information for the proper maintenance and repair of the MAXXAM.

The MAXXAM fits the needs of a wide variety of kart users above 16 years old. Those who will be servicing this kart should carefully review this manual before performing any repair or services.

All information, illustrations, photographs and specifications contained in this manual are based on the latest product information available at the time of publication. Due to improvements or other changes, there may be some discrepancies in this manual. Therefore, if newest information is requested in the future, please contact the local distributor.

The distributor reserves the right to make production changes at any time, without notice and without incurring any obligation to make the same or similar changes to vehicles previously built or sold.



ACE
SPORTS

A.C.E. SPORTS

239 County Road 4435
Brundidge, AL36010
Phone: 888.562.9ACE
Fax:888.562.8ACE

TABLE OF CONTENTS

GENERAL INFORMATION	1
PERIODIC MAINTENANCE AND TUNE-UP PROCEDURES	5
ENGINE	9
LUBRICATION SYSTEM INSPECTION AND SERVICING	24
FUEL SUPPLY SYSTEM INSPECTION AND SERVICING	28
TRANSMISSION COMPONENTS	33
ELECTRICAL STARTING SYSTEM	34
REDUCTION MECHANISM	37
CONTROLLING MECHANISM	39
BELT DRIVEN CVT MECHANISM INSPECTION AND SERVICING	40
CLUTCH	44
DRIVEN BELT PULLEY	46
REAR TRANSMISSION MECHANISM INSPECTION AND SERVICING	49
ELECTRICAL SYSTEM	54
PRIMARY COIL	56
IGNITION SYSTEM INSPECTION AND SERVICING	60
CHASSIS	64
WIRING DIAGRAM	70
INDEX	71

GENERAL INFORMATION

MODEL IDENTIFICATION

FRAME NUMBER

The frame number or VIN is stamped under the seat on the frame cross member and on a sticker behind the seat.

ENGINE NUMBER

The engine number is located on the lower front left side of the engine case.

FUEL AND OIL RECOMMENDATIONS

Be sure to use the specified fuel and oil.

FUEL

Gasoline should be 85 to 95 octane or higher.
Unleaded gasoline is recommended.

ENGINE OIL

High-grade 10W-40 motor oil should be used.

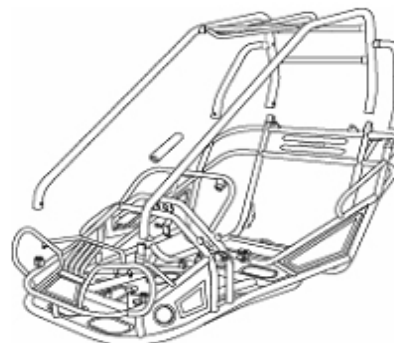

BREAK-IN PROCEDURE

- For the first 2 hours of riding, do not exceed 2/3 throttle.
- Vary engine speed for the first 5 hours.
- Never hold engine at full throttle for long periods of time.

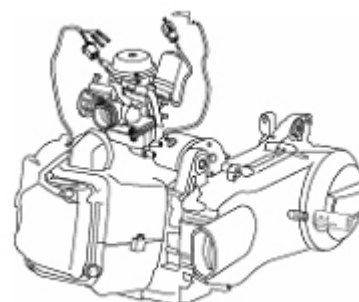

SPECIFICATIONS

DIMENSIONS	
Overall length	2075mm (87.7 in.)
Overall width	1235mm (48.6 in.)
Overall height	1400mm (55.1 in.)
Wheelbase	1450mm (57 in.)
Front Track	1060mm (47.1 in.)
Rear Track	1000mm (39.4 in.)
Ground Clearance	130mm (5.1 in.)

ENGINE	
Type	Forced air-cooled, 4-stroke
Engine capacity	150cc
Bore x stroke	57.4 x 57.8
Corrected Compression Ratio	9.2:1
Carburetor	PD25J
Output Power	9HP/7500 rpm
Maximum Torque [N.m(r/min)-1]	8.0/4000-4500
Starting	Electric
Ignition	CDI
Lubrication	Force & Splash
Transmission	Automatic CVT

CAPACITIES	
Load	1 rider or 90kg/198lbs
Fuel tank	7L/1.54Gal
Starting	5s
Climbing	20-25°

CHASSIS	
Front Brake	Hydraulic disc/left foot control
Rear Brake	Hydraulic disc/left foot control
Front Tire	20 x 7.0-8
Rear Tire	22 x 10-10
Suspension-Front	Dual A-arm with 1.8" (45mm) of travel
Suspension-Rear	Spring over shock with 2.4" (60mm) of travel
Brake Track	7m@20mph
Top Speed	30mph (or limited as customers require)

WEIGHT

Dry Weight	155kg/341lbs
------------	--------------

TIRE PRESSURE

Front	10Psi (68.95kPa/cm ² , 0.70kgf/cm ²)
Rear	10Psi (68.95kPa/cm ² , 0.70kgf/cm ²)

* The specifications are subject to change without notice.

LOCATION OF PARTS



ENGINE START SWITCH ENGINE STOP BUTTON

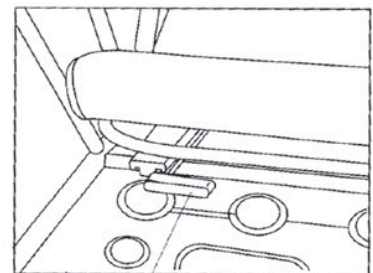
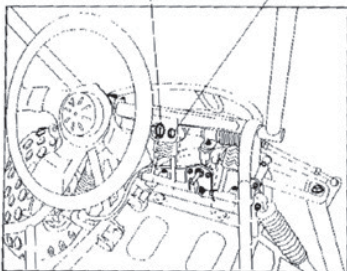

DRIVE CHAIN

DRIVER SEAT LOCK SWITCH

PERIODIC MAINTENANCE AND TUNE-UP PROCEDURES

PERIODIC CHECK AND SERVICES

The maintenance intervals in the following table are based upon average riding conditions. Riding in unusually dusty areas requires more frequent servicing.

Items Needing Servicing	Initial Service (first week)	Monthly	Quarterly	Yearly
Tire pressure/wear	I	I		
Brake performance	I	I		
Tightness of screws	I	I		
Air cleaner		C	C	I
Carburetor	I	A		C
Spark plug			C, A	
Drive chain	I	I	C, A, L	
Brake fluid			I	
Replace gearbox oil		I	R	
Chassis		C, L	L	
Fuel switch/fuel tank				C
Battery	I		I	
Engine oil		R		
Valve clearance of engine			A	

A: Adjust C: Clean I: Inspect, clean or replace if necessary L: Lubricate R: Replace

MAINTENANCE AND TUNE-UP PROCEDURES

Descriptions of the servicing procedures for each item in the Periodic Maintenance table.

SPARK PLUG

Note: The spark plug should generally be serviced when the engine is cold.

- Clean up the carbon around the spark plug to prevent it from dripping into the cylinder when being removed.
- Remove the spark plug
- If the spark plug is too tight to remove, spray rust inhibitor on the spark plug washer and the thread. After soaking for a few minutes, the spark plug should easily unscrew.
- Clean up any dirt and carbon accumulation on the spark plug with a steel brush or a blade.
- Inspect the spark plug gap, it should be about 0.6 ~ 0.7mm.
- When the carbon accumulation and wear of the spark plug are too severe, replace the spark plug with one of the same specification.

TIRE PRESSURE/WEAR

Check the tire pressure every time the kart is ridden. The tire pressure is very important for the stability of the ride.

Tire Pressure			
Front	10 psi	68.95kPa/cm ²	0.70kgf/cm ²
Rear	10 psi	68.95kPa/cm ²	0.70kgf/cm ²

BRAKE PERFORMANCE

- Always check that there is plenty of brake fluid in the brake fluid reservoir.
- Check that the rear brake pads are in good condition.
- Check the brake rotor for abnormal wear.

AIR CLEANER

Note: Clean after every 20 hours of use, or more often if used in a dusty environment.

If the air cleaner is clogged with dust, performance will be severely decreased, if left unserviced, engine damage can occur. Check and clean in the following appropriate manner.

Paper Filter Maintenance

- Remove the air cleaner from its housing.
- Tap filter on a hard object to knock dust from the filter.
- Replace the element if it is wrinkled or torn.

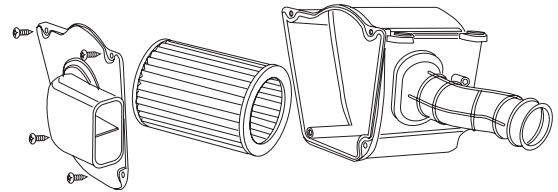

Foam Filter Maintenance

- Remove foam filter from steel cage.
- Wash in non-flammable cleaning solvent.
- Install the element back into the air box.

Caution! Before and during cleaning, inspect the element for tears. A torn element must be replaced. Make sure the element is seated properly and no foreign material can pass by it.

THROTTLE CABLE ADJUSTMENT

- Conditioning nut, bolt from the adjustment nut goes farther, the greater the degree of throttle opening, the smaller the contrary. The greater the degree of throttle opening, the higher the Idle

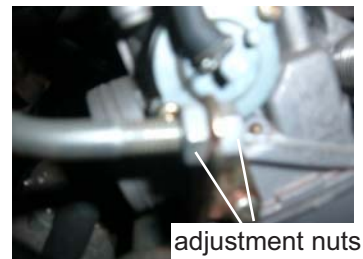

CHASSIS NUTS AND BOLTS

Note: *Inspect the first week and then every month thereafter.*

Always pay attention to the kart's nuts and bolts. Some loosening after use is normal. Check to ensure that all nuts and bolts are tight.

Torque Tightening Chart

Bolt Diameter	Conventional Marked Bolt			8.8 Marked Bolt		
	N.m	Kg.m	lb-ft	N.m	Kg.m	lb-ft
4	1 ~ 2	0.1 ~ 0.2	0.7 ~ 1.5	1.5 ~ 3	0.15 ~ 0.3	1.0 ~ 2.0
5	1 ~ 4	0.2 ~ 0.4	1.5 ~ 3.0	3 ~ 6	0.3 ~ 0.6	2.0 ~ 4.5
6	4 ~ 7	0.4 ~ 0.7	3.0 ~ 5.0	8 ~ 12	0.8 ~ 1.2	6.0 ~ 8.5
8	10 ~ 16	1.0 ~ 1.6	7.0 ~ 11.5	18 ~ 28	1.8 ~ 2.8	13.0 ~ 20.0
10	22 ~ 35	2.2 ~ 3.5	16.0 ~ 25.5	40 ~ 60	4.0 ~ 6.0	29.0 ~ 43.5
12	35 ~ 50	3.5 ~ 5.5	25.5 ~ 40	70 ~ 100	7.0 ~ 10.0	50.5 ~ 72.5
14	50 ~ 80	5.0 ~ 8.0	36.5 ~ 58	110 ~ 160	11.0 ~ 16.0	79.5 ~ 115.5
16	80 ~ 130	8.0 ~ 13.0	58 ~ 94	170 ~ 250	17.0 ~ 25.0	123.0 ~ 181.0
18	130 ~ 190	13.0 ~ 19.0	94 ~ 137.5	200 ~ 280	20 ~ 28.0	144.5 ~ 202.5

FUEL SWITCH (PETCOCK)

- Periodically clean the petcock externally with grease remover and water.
- Check for any leaks or seeping fuel.
- Replace the petcock if there are any leaks found.

This vehicle has a manually operated fuel valve. There are three positions.

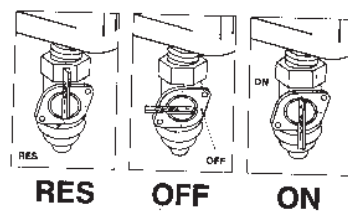

“ON” position

The normal operating position for the fuel valve lever is the “ON” position. In this position, fuel will flow to the carburetor.

“RES” position

If the fuel level in the fuel tank becomes too low for the engine to operate with the fuel valve lever in the “ON” position, turn the lever to the “RES” position to use the reserve fuel supply, and refuel as soon as possible.

“OFF” position

The closing position for the fuel valve is the “OFF” position.

When the vehicle is not in use, always make sure the petcock is in the “OFF” position.

FINAL GEAR OIL

Note: *Inspect monthly and change quarterly.*

Note: *80/90 weight gear oil is recommended in the final drive case. However, in extreme cold weather conditions, you may notice that the kart is hard to push. If that is the case, use lighter viscosity oil, such as 75 weight or equivalent motorcycle transmission fluid.*

- To check level, remove level screw on the left rear engine case.
- To drain oil, remove the drain plug at the rear bottom of the engine case. It is recommended to warm the engine for 10 minutes or more before draining final gear oil.

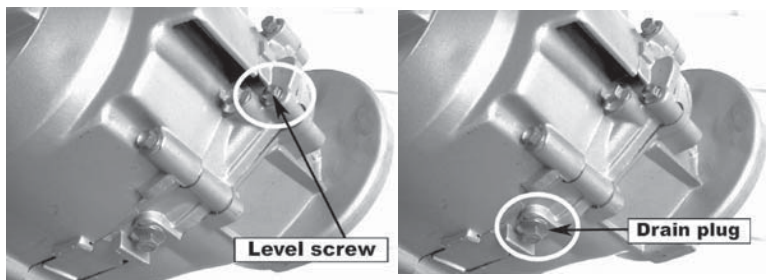

Final drive capacity	
80ml	80/90 weight

ENGINE OIL

Note: *Inspect before each use. Change monthly.*

- Remove the drain plug from the left side bottom of the engine. Drain into oil pan for disposal.
- Remove the large cap on the right bottom of the engine and remove the screen.
- Wash the screen with cleaning solvent and refit, making sure the O-ring is still in good condition. Replace screen and drain plug.
- Refill the engine with 10W-40 engine oil and run for 5 minutes.
- Check oil level on the filler cap stick to assure proper level.
- The cap needs to be screwed in for a proper reading.

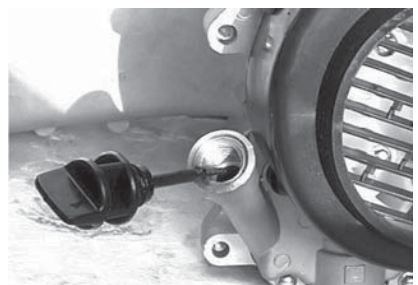
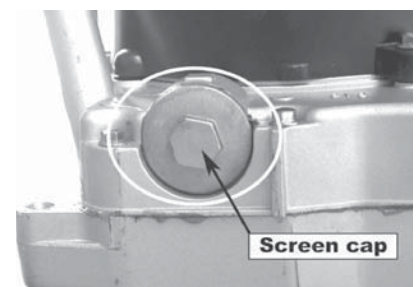
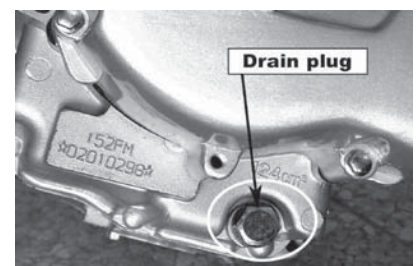

CHASSIS

Grease chassis bushings and bearings with grease quarterly to assure smooth operation and extended life of the bushings and the components. If used in extreme wet and muddy conditions or dusty conditions, greasing is recommended more often.

CARBURETOR

Refer to Carburetor section.

VALVE CLEARANCE

Refer to Engine section.

ENGINE

ENGINE COMPONENTS INSPECTION AND SERVICING
ENGINE COMPONENTS AND CRANK CONNECTING ROD
MECHANISM INSPECTION AND SERVICING

ENGINE COMPONENTS: CYLINDER

CYLINDER REMOVAL

The removal can be done on the vehicle body.

- Remove cylinder head.
- Remove cylinder.
- Remove cylinder gasket, bolts
- Clean cylinder gasket and remove any debris.

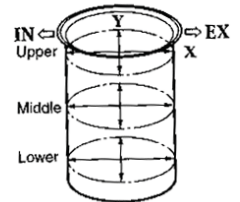
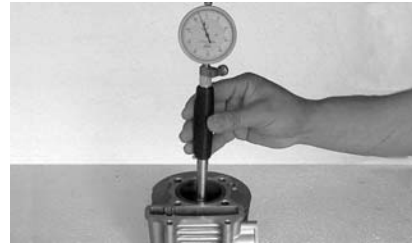

Caution!

Do not damage the cylinder area. Make sure not to drop anything, including cylinder gasket material, into the crankcase.

CYLINDER INNER WALL WEAR INSPECTION

Use a bore diameter dial gauge to measure the degree of wear.

The measure point is divided into three sectional planes in the axial direction: upper, middle and lower; measure every plane each time on the mutually perpendicular directions (X, Y), the measured least dimension is the cylinder bore; at the most upper position measured is the largest diameter, and the lowest position measured is the smallest diameter, their difference is the cylindricity of the cylinder. At the same cross section, measure the difference of diameter between two points mutually perpendicular; which is the circularity of the cylinder.

In order to make the measuring point perpendicular with the bore axis of the cylinder, and to ensure the precision of the measurement, the bar of the gauge can be slightly swung in the direction of the gauge bar, and take the smallest reading number as the result.

In the situation without a dial gauge, a feeler gauge can be used to make relativity measurement. Put a new piston into the cylinder, and use the feeler gauge to measure the gap between the piston skirt and the cylinder wall. Then figure out the abrasion loss of the cylinder. If the circularity of the cylinder exceeds the limit, then a cylinder reboring machine should be used to rebores the cylinder, and enlarge its diameter by 0.5mm or 1.00mm, then fit the piston and piston ring which size are also enlarged. If the wear is too severe and cannot be reworked, then a new cylinder should be installed.

Cylinder bore	57.4mm
Cylindricity	0.05mm
Circularity	0.05mm

CRANK CONNECTING ROD MECHANISM: PISTON SET

PISTON PIN INSPECTION AND SERVICING

- Insert the piston pin horizontally into the piston pin hole, and inspect the clearance between piston and piston pin.

Service Limit	0.02mm
----------------------	--------

If the free play is too much, the worn condition of piston pin and piston pin hole must be inspected respectively.

- Measure the external diameter of piston pin.

Service Limit	14.98mm
----------------------	---------

If the result is less than the Service limit, it should be replaced.

After replacement, check the clearance between piston pin and piston pin hole and make sure it complies with the required measurement.

- Measure the inner diameter of piston pin.

Service Limit	15.02mm
----------------------	---------

If the result is more than the service limit, it should be replaced.

After replacement, check the clearance between the holes of the piston pin and make sure it complies with the required measurement.

PISTON RINGS INSPECTION AND SERVICING

- Inspect the piston ring for flaws, serious wear, or serious conglutination, etc. If there is, it should be replaced.
- If the piston ring's lateral clearance and notch clearance are too large or too small it will cause malfunctions, so it must be measured.
- Measure the clearance of the piston ring in the piston ring groove. This clearance is the piston ring's lateral clearance.

First Ring	0.09mm
Second Ring	0.09mm

CONNECTING ROD END INSPECTION

- Put the piston pin and bearing into the connecting rod end; inspect the degree of tightness of the piston pin in connecting rod end.
- Measure the inner diameter of the connecting rod end.

Service Limit	15.06mm
----------------------	---------

When the abrasion of the bore exceeds the limitation, it should be replaced.

PISTON RINGS SET UP

Before setting up, apply oil on each piston ring, then enlarge piston rings; at the same time put them on the piston and move downwards gradually, until piston rings fall into the ring groove.

PISTON SET INSTALLATION

- Remove the gasket attached to the crankcase.
- Mount piston onto the small end of the connecting rod.

The top of the piston marked with "IN" should be mounted towards the direction of the inlet port (if the mark is "EX", then it should be mounted towards the direction of the exhaust port).

- Mount piston pin and piston pin clip
- Apply oil on the piston pin to lubricate it.

Cover the crankcase port with a piece of cloth to keep the piston clip from dropping into the crankcase.

CRANK CONNECTING ROD SET

The connecting rod is the component that links the piston and crank. The picture shows the structure and assembling relations of the crank connecting rod component.

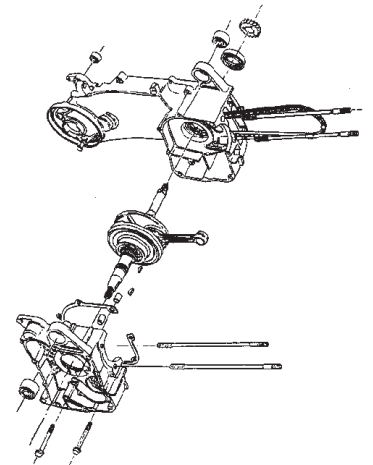

CRANKCASE AND CRANKSHAFT REMOVAL

Before removing the crankcase and crankshaft, follow these procedures:

- Remove the engine.
- Remove the cylinder cover.
- Remove the cylinder.
- Remove the piston.
- Remove the drive plate and the driven plate.
- Remove the AC generator.
- Remove the starting motor.
- Remove the oil pump.
- Then remove the cam chain tensioner bolt. Remove the cam chain tensioner.
- Use special tools to remove the starting driven gear.

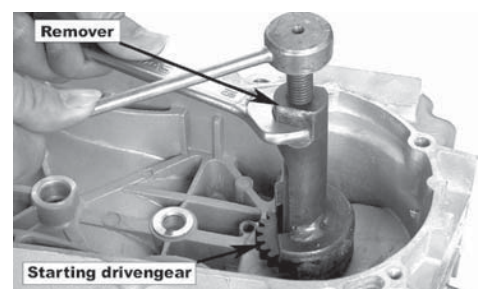

- Remove the crankcase positioning bolts.
- Separate the right crankcase and the left crankcase.

Be careful not to damage the joint face.

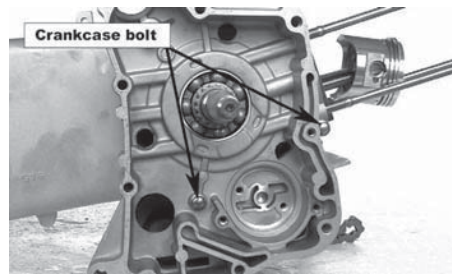

- Remove the gasket and the dowel pins.

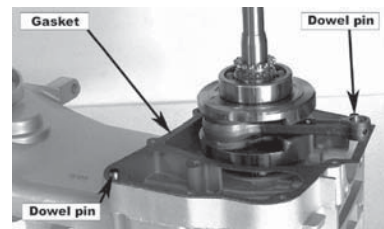

- Remove the crankshaft from the crankcase.
- Take out the cam chain.

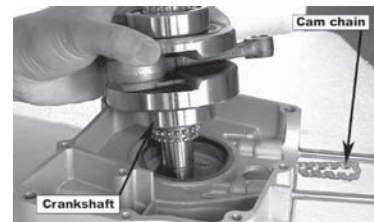

- Remove the gasket on the crankcase joint face, be careful to not damage the joint face.

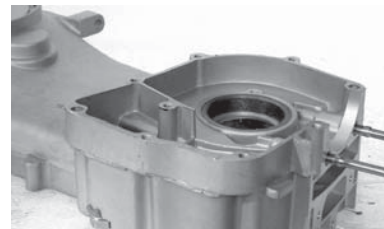

- Remove the oil seal from the left crankcase.

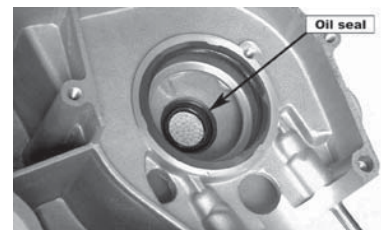

- Remove the oil seal from the right crankcase.

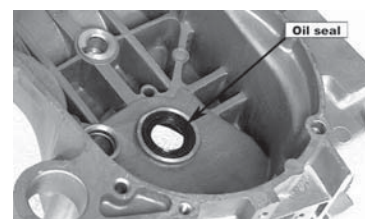

CRANKSHAFT AND CRANKCASE INSPECTION

- Replace the whole set of the crankshaft if serious wear is found while inspecting. Measure the axial trend clearance of the big end of the connecting rod.
- When measuring, put the large end of the connecting rod close to the crank, and insert the feeler gauge between the other side and the crank, for the correct end play.

Service Limit	0.55mm
----------------------	--------

- Measure the radial trend (X,Y) clearance of the big end of the connecting rod.

Service Limit	0.05mm
----------------------	--------

- Measure the main shaft journal jump of the crankshaft.
If this measurement is too great, it will cause the engine to shake abnormally, shortening the life of the engine. It must be examined carefully when inspecting.

Service Limit	0.10mm(A=90)
	0.10mm(B=105)

- Examine if there is any loose, or unusual sound when the crank journal bearing turns. If there is, the whole set should be changed.
- After cleaning the crankcase, inspect to see if there is any damage.
- Inspect whether the joint face of the crankcase is smooth and clean. While reassembling, notice if it will affect the sealing performance between the left and right crankcase.
- After the above inspection, if the crankcase has some surface damage, use oilstone to refinish it. If damage is too severe, replace the cover.

Because the right and left crankcase axle hole must be concentric, they should be replaced at the same time.

CRANKSHAFT AND CRANKCASE INSTALLATION

- Mount the crankcase oil seal.
- Put the cam chain into the left crankcase.
- Put the crankshaft into the left crankcase.



Pay attention to avoid damaging the oil seal with the cam chain.

- Mount the new dowel pins and gasket on the left crankcase. Then join the right crankcase and left crankcase together.
- Tighten the crankcase positioning bolts.

Tightening Torque 1.98 lbs/m

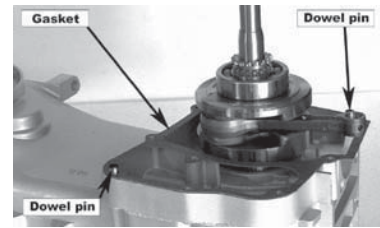

- Mount the starting driven gear.
- Mount the cam chain tensioner.
- Mount the new O-ring on the cam chain tensioner bolt.
- Apply some oil on the O-ring.
- Tighten the cam chain tensioner bolt.

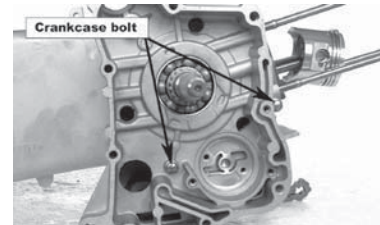

The O-ring must be mounted in the groove.

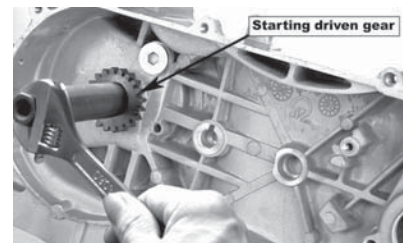

VALVE MECHANISM INSPECTION AND SERVICING

The picture shows the common valve train of a four-stroke engine. This is a kind of overhead valve train, its intake port, exhaust port, cam shaft are all located in the cylinder head, the valves bottom up over the combustion chamber.

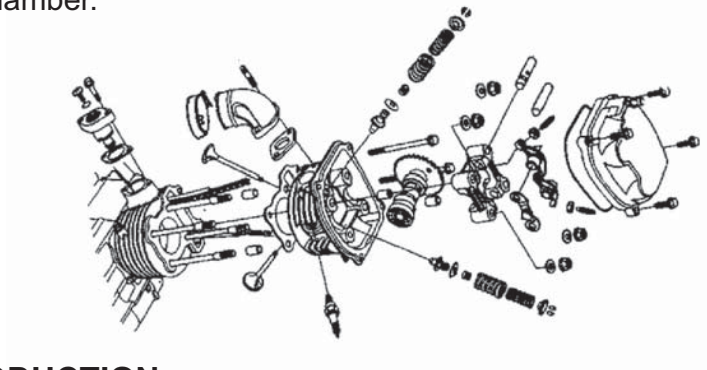

GENERAL INTRODUCTION

The four-stroke engine completes its four stroke with one piston stroke.

- Intake stroke
- Compression stroke
- Expansion stroke
- Exhaust stroke

VALVE CLEARANCE ADJUSTMENT

Valve clearance is an important technical parameter in the valve train. In order to enable the engine to run properly, especially when the engine is overheated, or in cold conditions a certain clearance must be kept. This clearance is called valve clearance. When the engine is running, the valve clearance must not be too big or too small.

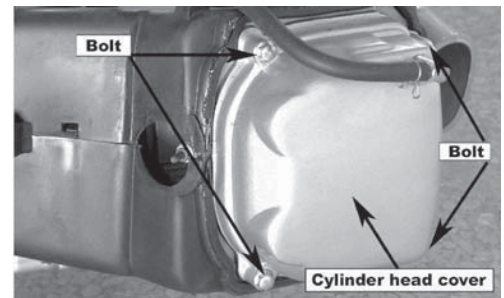

- Remove the cylinder head cover.

Inspection and adjustment should be done in cool conditions (below 35°C).

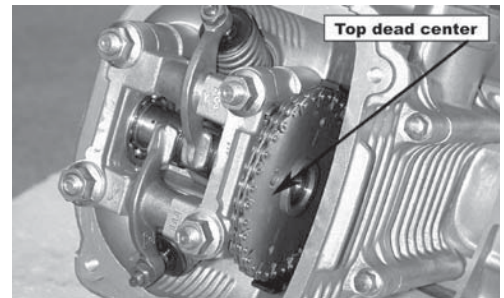

- Turn the cooling fan clockwise until the mark of the timing drive sprocket on the camshaft is at the top, dead center, and the "T" symbol (or other mark) of the magneto flywheel aligns to the crankcase mark.

The crankshaft should rotate, or the exhaust port may not be adjusted.

- When adjusting, loosen the lock nuts, adjust the bolts with a valve-adjusting wrench. When turned clockwise the valve clearance decreases. When turned counterclockwise the valve clearance increases. Put a feeler gauge with specific sizes between the valve and rocker to check for correct clearance.

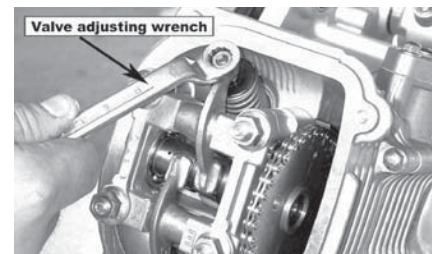

- Take out the feeler gauge, tighten the lock nuts, and then inspect the valve clearance again.

Sometimes when tightening the lock nuts the clearance will change, so it must be rechecked for the proper clearance.

Valve Clearance 0.08 ~ 0.12mm

CAMSHAFT

The camshaft is the main driving unit of the valve train. The air inlet cam, the exhaust cam, and the cam journal are on the shaft. It causes the intake and exhaust valve to open and close at the correct time. Wear to the camshaft will affect engine performance and cause excessive noise.

CAMSHAFT REMOVAL

- Loosen valve cover bolts and remove cover.
- Remove the cam chain tensional bolt cap, and remove the O-ring.
- Tighten the cam chain tensioner by adjusting bolt clockwise.
- Turn the flywheel counterclockwise to make the “ T” mark on the flywheel align with the mark on the crankcase. When the hole on the cam chain (timing drive chain wheel) is up, it should be at the top, dead center.
- Remove the cylinder head positioning bolt.
- Remove the camshaft holder bolt cap and washer.
- Remove the camshaft holder and dowel pin.
- Remove the cam chain wheel from the cam chain, and remove the camshaft.

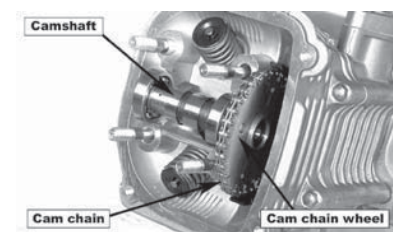
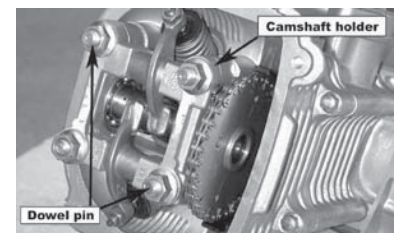
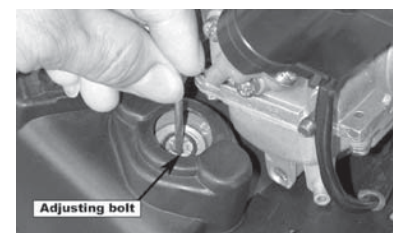
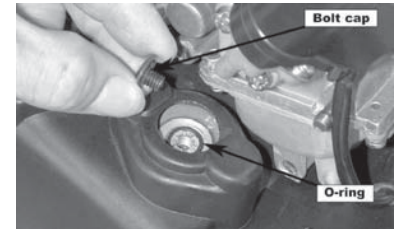

CAMSHAFT INSPECTION

- Inspect the camshaft bearings for play. If there is too much play, replace the whole set.
- Inspect cam surface for damage.
- Measure the height of the cam.

Inlet Cam	25.96mm
Exhaust Cam	25.815mm

CAMSHAFT INSTALLATION

- Rotate the flywheel to align the “T” mark on the flywheel with the camshaft mark. The round hole on the cam chain wheel should be up, and the left and right sit parallel with the cylinder head (the lobes of the camshaft are down). Then install the camshaft on the cylinder head.
- Mount the cam chain on the chain wheel.
- Install the dowel pins.
- Mount the camshaft holder, washer and bolt cap on the cylinder head.
- Tighten the cylinder head bolt and nut.

While installing, apply some oil on the thread of the camshaft holder bolt. The camshaft nuts should be tightened diagonally in a 3-step process. After installing, adjust the valve clearance.

- Turn the cam chain tensioner adjusting bolt counter-clockwise, and release the lock.
- Apply oil on the new O-ring.
- Mount and tighten the cam chain tensioner cover bolt.

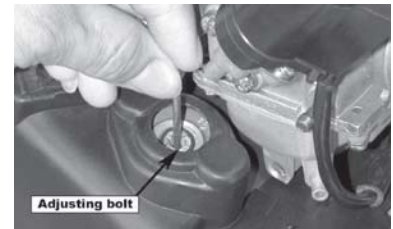

The O-ring must be mounted properly in the groove.

- Replace the valve cover gasket, and mount the cover.

The valve cover gasket must be properly mounted in the groove.

- Tighten the valve cover-positioning bolt.

ROCKER ARM AND ROCKSHAFT

ROCKER ARM AND ROCKSHAFT REMOVAL

- Remove the camshaft holder.
- Take out the rockshaft by removing the bolt.
- Remove the rocker arm.

ROCKER ARM AND ROCKSHAFT INSPECTION

Inspect if there is any abrasion or damage on the rocker arm and rockshaft or if the oil hole is clogged.

If there is abrasion on the surface of the rocker arm, the camshaft should also be inspected.

- Measure the inner diameter of the rocker arm.

Service Limit	10.04mm
----------------------	---------

- Measure the outer diameter of the rockshaft.

Service Limit	9.96mm
----------------------	--------

ROCKER ARM AND ROCKSHAFT INSTALLATION

- Read the “EX” mark on the camshaft holder, then mount the exhaust port rocker arm to the rockshaft.
- Mount the inlet port rocker arm to the rockshaft. Apply some oil to the rockshaft before mounting.

CAM CHAIN TENSIONER

The chain tensioner must be in good working condition for proper chain tension.

1. Cam chain
2. Cam chain tensioner
3. Cam chain tensioner lifter.
4. Gasket
5. Cam chain tensioner pivot
6. Cam chain guide
7. Bolt
8. Nut
9. O-ring
10. O-ring

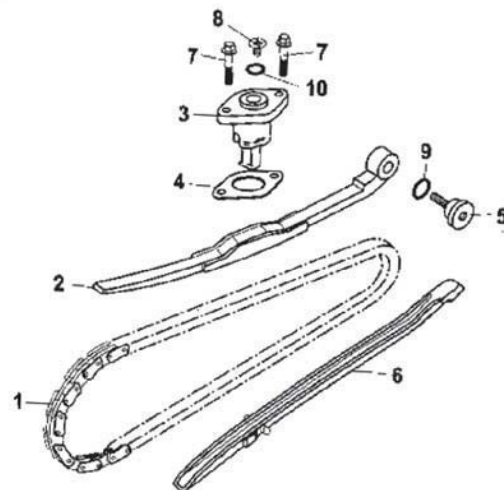

The operational principle of the tensioner is as shown in the picture.

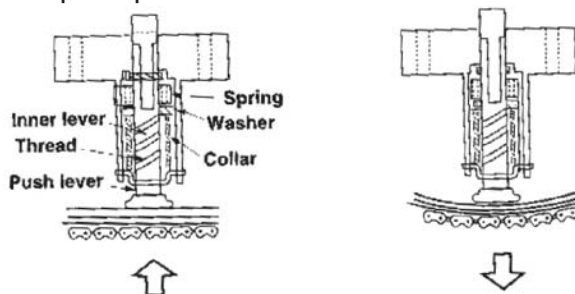

As for the adjustment of the cam chain tensioner, clockwise tightens, and counterclockwise loosens.

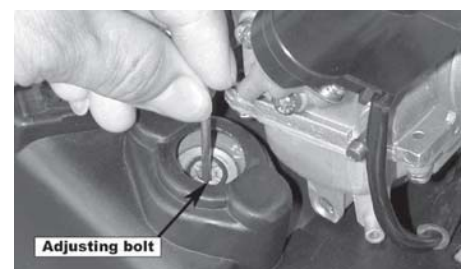

VALVE AND VALVE SPRING

VALVE AND VALVE SPRING REMOVAL

- Remove cylinder head.
- Remove valve cotter pin and compressor.
- Remove upper spring race.
- Remove valve spring.
- Remove lower spring race.
- Remove valve stem oil seal.
- Remove valve.

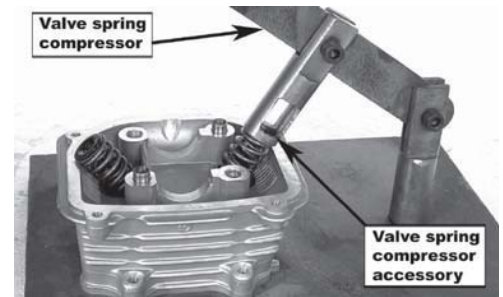

The removed parts should be placed in order to avoid confusion. It's better to place the intake valve parts and exhaust valve parts separately.

VALVE AND VALVE SPRING INSPECTION

- Inspect the valve for bending or burning.
- Inspect for smooth action between the valve and the valve guide.
- Measure the outer diameter of the valve stem.

Service Limit	4.94mm
----------------------	--------

- Measure the free length of the inner and outer valve spring.

Valve	Inlet valve	Exhaust valve
Inner spring	31.2mm	31.2mm
Outer spring	34.1mm	34.1mm



VALVE AND VALVE SPRING INSTALLATION

- Mount the spring retainer, valve guide oil seal.

It is recommended to replace the valve guide oil seal with a new one.

- After applying oil on the valve stem, mount it into the valve guide.
- Mount the inner and outer valve springs.
- Mount the valve locker with a spring compressor.

When mounting, the twisting direction of the inner and outer springs must be opposite.

- Tap on the valve gently two or three times with a rubber hammer to make the valve and the valve lock connect well.

Do not damage the valve.

VALVE GUIDE

Carbon accumulation on the valve guide will make the valve move roughly, causing the valve to not open or close properly.

Valve guide abrasion is one of the causes of white smoke from the exhaust pipe.

TO CLEAN CARBON ACCUMULATION OFF THE VALVE GUIDE

- Remove the valve and springs etc.
- Clean the carbon accumulation with a valve guide reamer.

Generally, only turn right when using the reamer, and do not push in or out directly with the reamer.

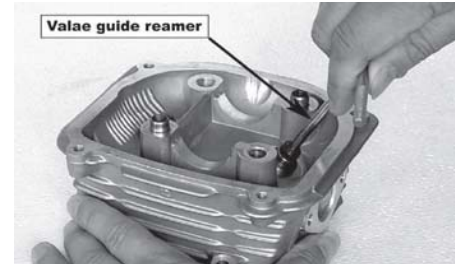

VALVE GUIDE INNER DIAMETER MEASUREMENT

Service Limit 5.03mm

Calculate the clearance between the valve stem and the valve guide (the inner diameter of the guide subtracted by the outer diameter of the valve stem).

Valve	Inlet valve	Exhaust valve
Service Limit	0.08mm	0.10mm



When the abrasion of the valve guide exceeds the service limit, it should be replaced; after replacing a new valve guide, the valve retainer must be adjusted.

VALVE GUIDE REPLACEMENT

- Heat the cylinder head to 212 ~ 302°F (100 ~ 150°C)

The cylinder head must be wholly and quickly heated to the specific degree, and cannot be heated partly, or it will cause the cylinder head to distort. The temperature is very high, two technicians are recommended.

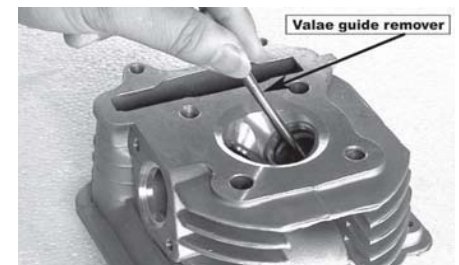

- Tap the valve guide out with a valve guide remover or similar tool.

Do not damage the cylinder joint face

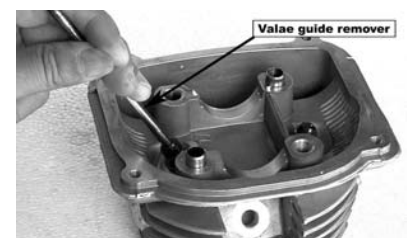

- After tapping the valve guide, you need to trim it with a reamer.

When using the reamer, cutting oil must be used. The reamer can only be turned right; do not push in or out directly.



- Clean the cylinder head, and remove the scraps generated while reaming.

VALVE SEAT

The relative position between the valve seat and the working surface of the valve is very important for the valve to seal properly.

VALVE SEAT WIDTH MEASUREMENT

- Clean the carbon accumulation in the combustion chamber.
- Measure the width of the valve seat with a vernier caliper.

Standard	0.6-1.2mm
Service Limit	1.8mm

When abrasion causes the valve seat width to be uneven, too wide or too narrow, it will result in poor contact between the valve and the valve seat, and not seal tight. At this time it must be reamed with a customized valve seat milling cutter.

The valve seat milling cutter is the customized trimming tool for the valve seat, and it has three cutting angles: 32, 45, and 60.

While trimming, press the valve seat milling cutter to make rotary motion with 40 ~ 50 N force.

Some oil must be applied on the valve seat milling cutter, to eliminate scraping when trimming.

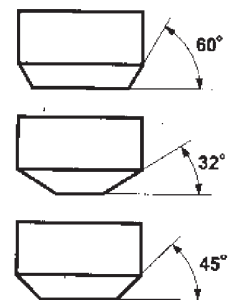
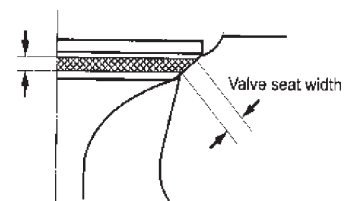

VALVE SEAT FINISHING

- Ream out the defects on the working surface with a 45° coarse tooth milling cutter.

Do not ream too much.

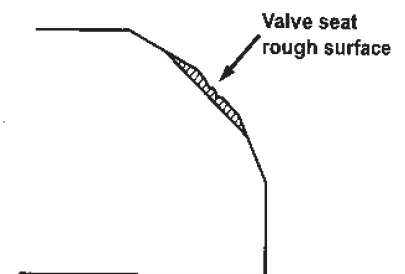

- Ream the upper angles of the valve seat working surface with a 30° milling cutter.

- Ream the lower angles of the valve seat working surface with a 60° milling cutter.

- Finally, ream the valve seat to the specific seat width with a 45° milling cutter.

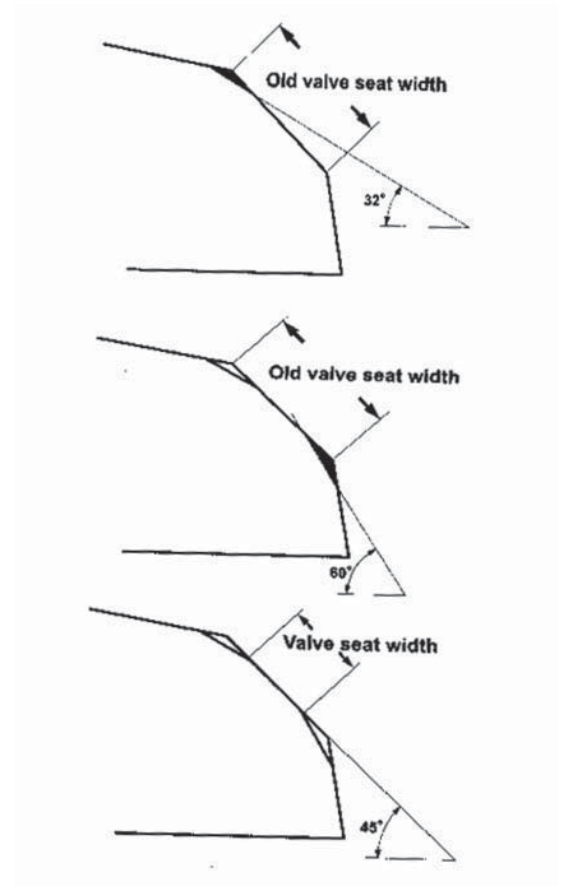

VALVE SEAT TOUCHING POSITION INSPECTION

Apply a thin layer of fluid on the valve seat. Place the valve on the seat and rotate jointly; then take out the valve and observe the contact surface on the valve face. If the contact position is too high, cut out some of the upper part of the valve seat with a 32° milling cutter to reduce the working face of the valve seat.

- If the contact position is too low, then cut out some of the lower part of the valve seat with a 60° milling cutter to raise the working face of the valve seat.
- Finally, mill the working face of the valve seat to the specific width with a 45° milling cutter.
- If the valve seat still cannot contact evenly with the valve after trimming, the valve should be revised or replaced.

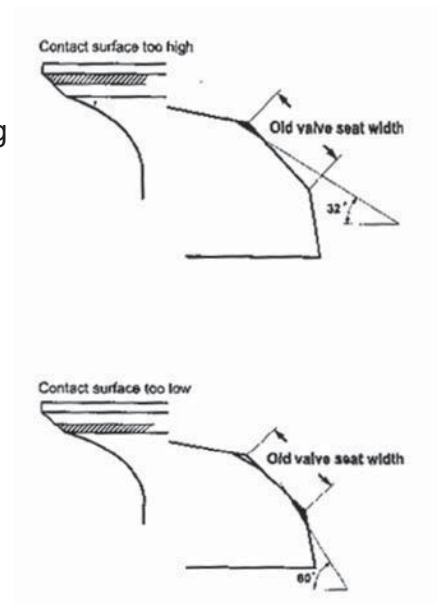

VALVE AND VALVE SEAT LAPPING

After finishing, the valve and seat should be lapped in order to make them seal properly.

Spread a thin layer of silicon carbide on the working bevel of the valve. Using a valve suction cup tool, repeatedly rotate the valve suction cup to lap the valve and valve seat evenly, until they match tightly.

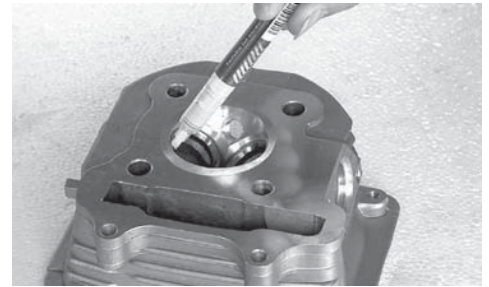

- Before lapping, clean the valve, valve seat and valve guide.
- When lapping do not use too much force.
- During lapping, do not drop any silicon carbide into the area between the valve lever and the valve guide.

VALVE AND VALVE SEAT AIR IMPERMEABILITY INSPECTION

After lapping the valve and valve seat, the air impermeability of the joint surface should be inspected.

Method One: Follow the same method as for “valve seat contact position inspection”.

Method Two: evenly draw several lines on the working surface of the valve with a pencil. Place the valve into the valve seat. Turn $1/8 \sim 1/4$ ring. If the lines are all broken, the level of air impermeability is satisfactory.

Method Three: Mount the valve on the cylinder head, and fill the inlet and exhaust vent with non flammable solvent, and preserve for 5 minutes, if there is no leakage, the valve is seated correctly.



LUBRICATION SYSTEM INSPECTION AND SERVICING

GENERAL INTRODUCTION

The picture shows the functional diagram of the lubrication system. After the lubrication oil crosses the filter screen, it is pumped by the rotator oil pump. Some of the oil goes into the big end of the connecting rod and splashes on the cylinder wall and the small end of the connecting rod; the rest goes through some oil passages, such as the shaft neck of the camshaft, and splashes on the cam rockshaft and cam chain. The lubrication oil that falls back into the oil groove can be recirculated.

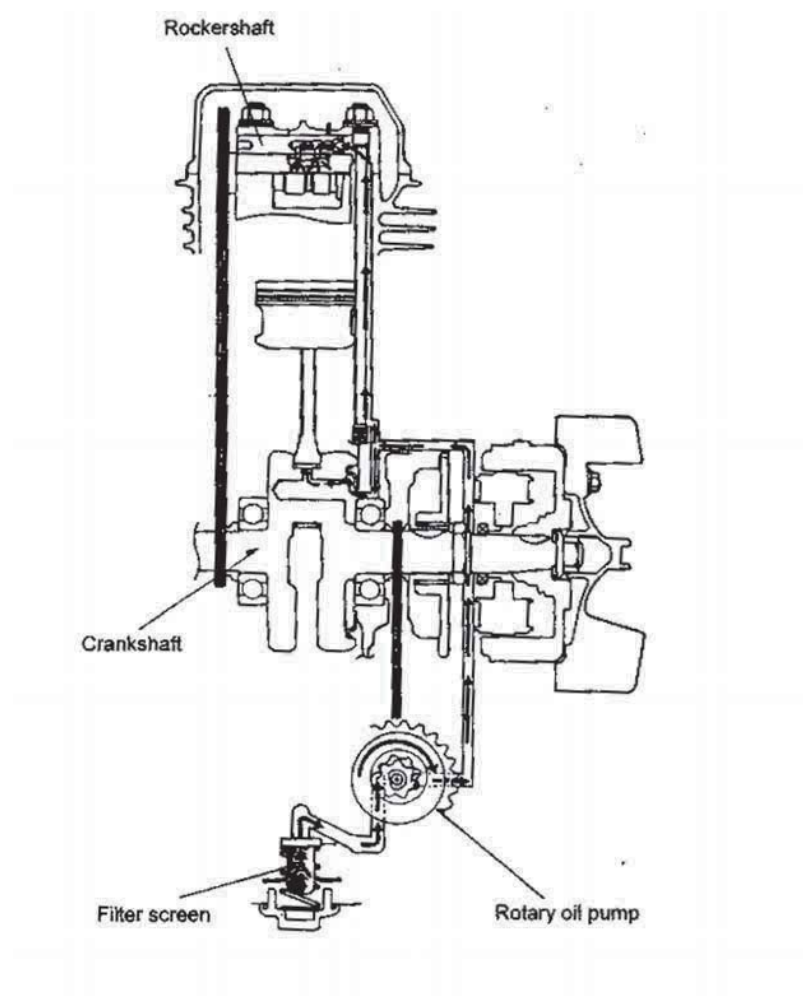

OIL SYSTEM INSPECTION AND REPLACEMENT

OIL REPLACEMENT

- Tighten the dipstick.
- Remove the oil filter screen cap and the screen to allow the oil flow out.
- Inspect the screen and O-ring. Replace if damaged.
- Mount and tighten the oil filter screen and the screen covers. Supply the application-specific oil to the appropriate level.

Oil Level	Disassembling	Replacing
	0.90l	0.75l

Start the engine and run for several minutes in the idle position to make sure there is no oil leakage. Stop the engine and inspect for proper oil level.

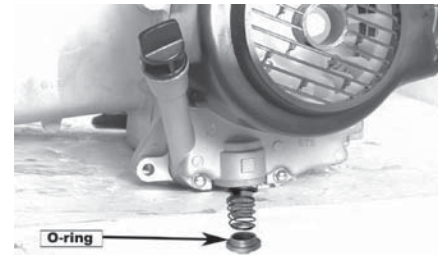
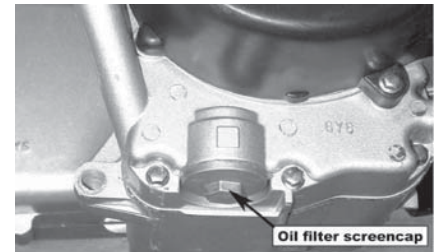

ROTARY OIL PUMP

The oil pump is the critical component of the lubrication system. Inspect and maintain it periodically. If damaged seriously, replace it as a unit.

OIL PUMP REMOVAL

- Remove the flywheel of the magneto.
- Remove the stator coil and trigger winding.
- Remove the right crankcase cover bolts, followed by removing the right crankcase cover.
- Remove the gasket and dowel pins.

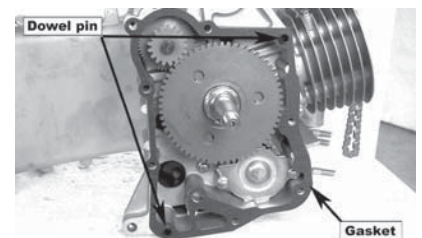
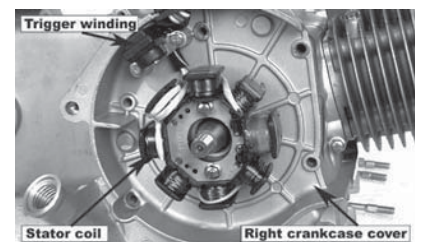

- Remove the starting reduction gear and starting clutch.
- Remove the oil pump partition plate positioning bolts, followed by removing the oil pump partition plate.
- Remove the oil pump driving gear nuts, followed by removing the driving gear and chain.

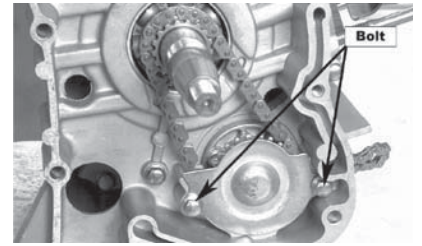

- After removing the oil pump positioning bolts, remove the oil pump assembly.

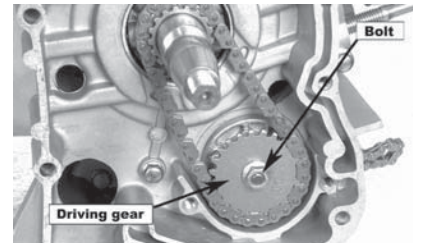

- Remove the screws, and disassemble the oil pump.

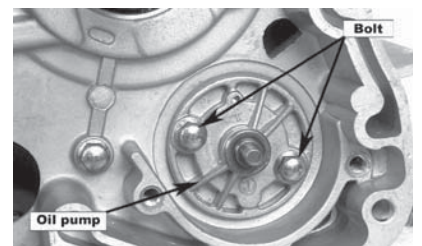

OIL PUMP INSPECTION

- Inspect the clearance between the oil pump body and the outer rotator.

Service Limit	0.12mm
----------------------	--------

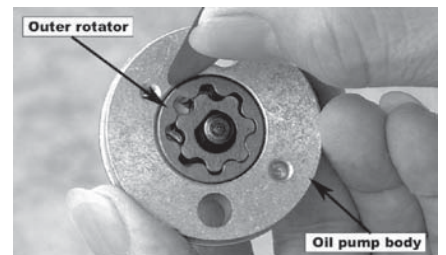

- Inspect the clearance between the inner rotator and the outer rotator.

Service Limit	0.12mm
----------------------	--------

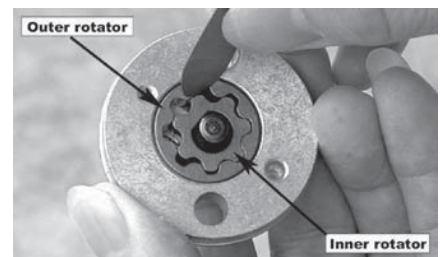

- Inspect the clearance between the rotator plane and the oil pump.

Service Limit	0.20mm
----------------------	--------

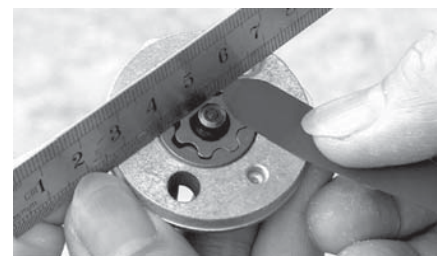

If the inspection result exceeds the above stated service limit, the whole set should be replaced.

OIL PUMP ASSEMBLING

- Assemble the inner and outer rotators of the pump, and mount the oil pump shaft.

When assembling, align the unfilled corner of the oil pump shaft with the corner of the inner rotator, and then mount.

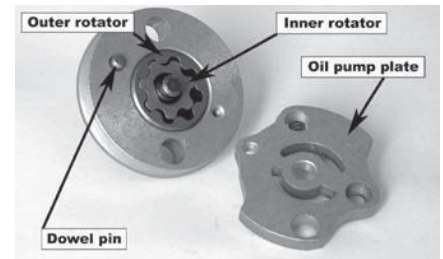

- Mount the dowel pin - you can install it after aligning the oil pump plate with the dowel pin.
- Tighten the oil pump plate bolts.
- After assembling, gently turn the oil pump shaft, and make sure the oil pump can turn smoothly.

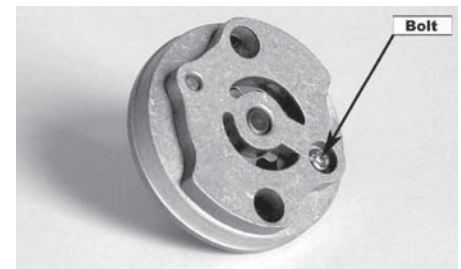

OIL PUMP INSTALLATION

- Install the oil pump on the crankcase.

Before installing, fill the oil pump with oil. When installing, the arrow of the oil pump body must be pointing upwards.

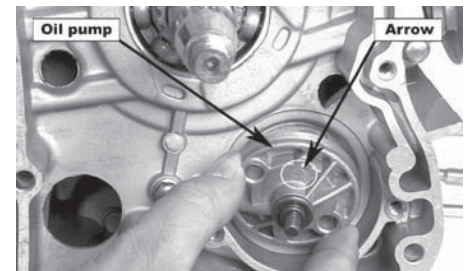

- Tighten the oil pump positioning bolts.
- Align the oil pump driving gear with the oil pump shafts unfilled corner, then mount the driving gear and chain.
- Mount the driving gear-positioning nut and tighten it.

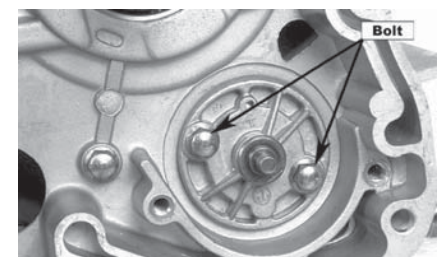

- Install the partition board and tighten bolts.

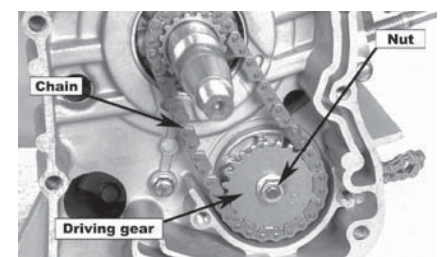

- Install the starting reduction gear and starting clutch.
- Mount the gasket and dowel pins.

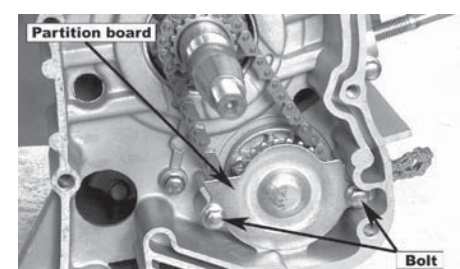

- Mount the right crankcase cover positioning bolt.
- Mount the trigger winding and the stator coil.
- Tighten the right crankcase cover positioning bolt.

The bolt should be gradually diagonally tightened in two to three steps. After finishing the installation, inspect for any oil leaks.

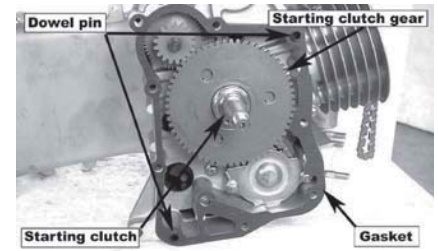

FUEL SUPPLY SYSTEM INSPECTION AND SERVICING

CV CARBURETOR

The CV carburetor is a constant vacuum carburetor. The picture shows the structure of the CV carburetor.

- | | | | |
|------------------------|-----------------------------|-------------------------|-----------------------|
| 1. Gasket Set A | 9. Air Cut Valve Set | 17. Binder | 25. Tube Clip (B7-99) |
| 2. Jet Set | 10. Compression Coil Spring | 18. Bystarter Cap | 26. Tube Clip (B8-98) |
| 3. Float Set | 11. Pan Screw M05X12 | 19. Rubber Tube | 27. Oil Tube 3.5X210 |
| 4. Float Chamber Set | 12. Oil Needle | 20. Pan Screw M04X8 | 28. Oil Tube |
| 5. Screw Set A | 13. Carbutetor Top | 21. Pan Screw M4X14 | 29. Main Jet # 112 |
| 6. Screw Set B | 14. Vacuum Piston Comp | 22. Screw-Washer M04X8 | 30. Slow Jet # 35 |
| 7. Valve Plate Set | 15. Float Valve Comp | 23. Screw-Washer M04X10 | 31. Carburetor Body |
| 8. Auto Bystarter Assy | 16. Needle Jet Holder | 24. Pan Screw M05X12 | |

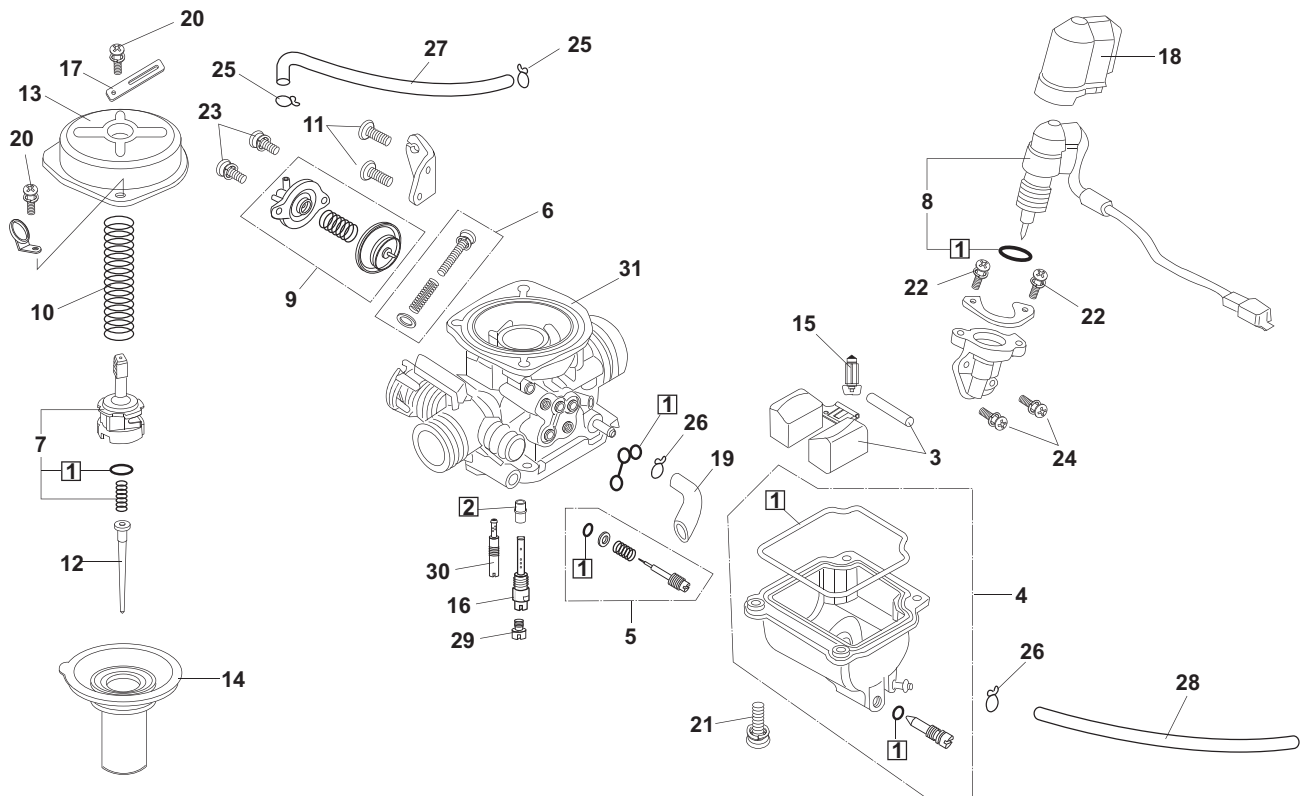

CARBURETOR IDLING ADJUSTMENT

AIR ADJUSTING SCREW ADJUSTMENT

Step one: Turn on the air adjusting screw in the turn out by the prescribed number of turns.

Turn out number of turns	2 3/4 – 2 1/4
---------------------------------	---------------

Step two: Adjust the throttle by adjusting the screw to the prescribed idle rpm.

Step three: Left and right, adjust the air adjusting screw slightly to find the highest position of the rpm.

Increase throttle quickly and gently (the rpm is from low to high), and return throttle immediately, then observe 10 to 15 minutes, to observe if the idle remains the same.

VACUUM CHAMBER

The picture shows the structure of the vacuum chamber of the CV carburetor.

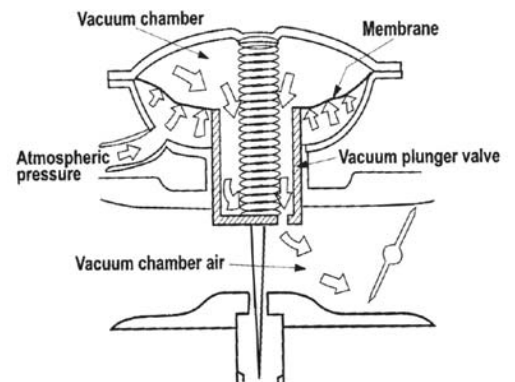

VACUUM CHAMBER REMOVAL

- Remove the body cover. Remove the automatic choke lead wire.
- Loosen the fuel drain bolt, and drain the fuel in the float chamber. Remove the fuel line and the vacuum pipe.
- Loosen the throttle cable adjusting nut and positioning nut; remove the throttle cable.
- Loosen the carburetor air inlet vent clip and the inlet manifold clip; remove the carburetor.

- Remove the vacuum cover bolt, and remove the vacuum cover. Notice: move slowly to prevent the spring from ejecting.

- Take out the spring, the vacuum membrane and the plunger.

- Press down the holding clamp of the needle valve top, and turn left to take out the clamp.
- Take out the spring and needle valve.

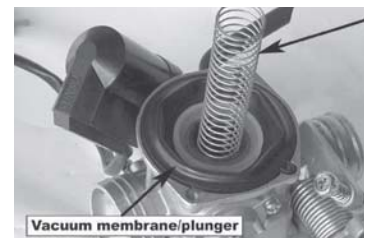
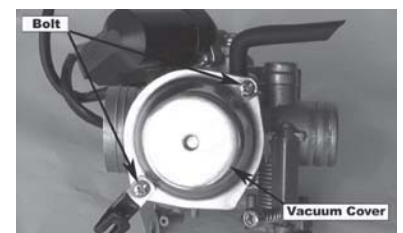

Do not damage the vacuum membrane.

- Inspect the needle valve for wear.
- Inspect the vacuum membrane for damage.
- Inspect the plunger for damage.

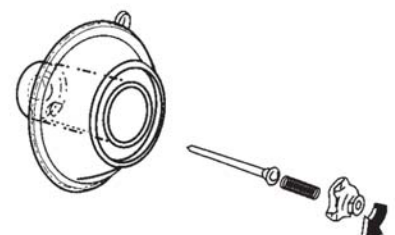

VACUUM CHAMBER INSTALLATION

- Mount the plunger and the vacuum membrane into the carburetor body.
- Push the plunger upwards in the direction of the vacuum chamber cover to open the carburetor jet tube. Insert the spring.
- Align the bulge part of the vacuum membrane with the fillister of the carburetor body; mount the vacuum chamber cover.
- Tighten the bolt.

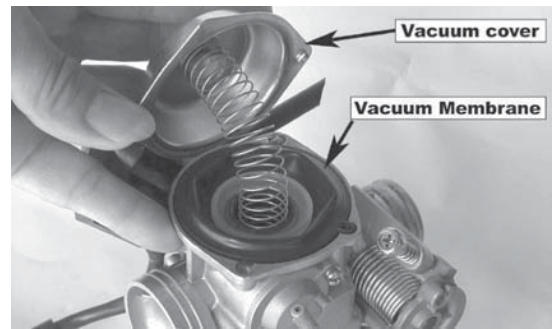

AUTOMATIC SIDE STARTER (CHOKE)

AUTOMATIC SIDE STARTER INSPECTION

- Remove the fuel hose from the carburetor.
- Turn out the carburetor float chamber drain screw, and drain the fuel in the carburetor.
- Remove the automatic side starter lead wire, and remove the clip.
- Remove the carburetor clamp, and remove the carburetor.
- Check the condition of the connection between the two lead wires.

The choke value should be below 10V. If it exceeds the specific value, it should be replaced. When the engine is cold, link a hose on the reserve supply fuel line and blow very gently. If it is obstructed or the auto side starter is not good, it should be replaced.

- Remove the auto side starter cover.
- Remove its positioning bolts and pieces.
- Remove the auto side starter.
- Inspect the auto side starting valve and fuel injection needle for wear.
- Inspect the O-ring for wear.

FLOAT CHAMBER

FLOAT CHAMBER REMOVAL

- Remove the carburetor.
- Remove the clamp, and remove the float chamber.
- Remove the O-ring; turn out the float chamber screw; remove the float pin; and remove the float and float valve.
- Remove the choke adjusting screw and air adjusting screw.

Before removing first tighten the two screws gently, counting the number of turns. Remove screws. Do not use excessive force to avoid damaging the air adjusting screw head surface.

- Remove the main fuel injection nozzle and fuel injection needle seat.

FLOAT CHAMBER INSTALLATION

Inspect the float for any damage and for fuel in the float. Inspect the float valve and float valve seat for wear. If there is wear, it should be replaced.

Clear every fuel line and air line on the carburetor body with compressed air.

FLOAT CHAMBER INSTALLATION

- Install the main fuel injection nozzle and fuel injection needle seat.
- Install the air adjusting screw and choke adjusting screw, and turn them to the proper position according to the noted number of turns while removing.
- Mount the float valve, the float, and the float pin.
- Tighten the float pin positioning screw.

FUEL LEVEL INSPECTION

- Measure the fuel level height.

Fuel level height	18.5mm
--------------------------	--------

- Inspect the float for any damage and inspect the float valve for excess wear.
- Confirm that the up and down movement of the float is normal.

CARBURETOR INSTALLATION

- Inspect the float for any damage and inspect the float valve for excess wear.
- Confirm that the up and down movement of the float is normal.

CARBURETOR INSTALLATION

- Reverse the removal procedure for installation.
- After installing, confirm that all carburetor linkage and cables are in correct position. Verify that carburetor is in idle position.

AIR CUT VALVE (ACV)

The air cut valve can avoid some abnormalities when the throttle closes too quickly.

The structure of the air cut valve is shown in the picture.

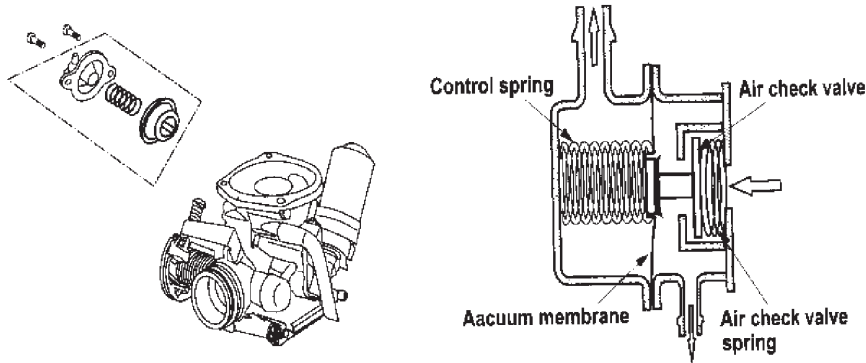

AIR CUT VALVE REMOVAL

- Remove the air inlet manifold of the cut valve.
- Remove the bolt. Remove the vacuum membrane cover, the spring, and the vacuum membrane.

AIR CUT VALVE INSTALLATION

- Mount the vacuum membrane on the carburetor.
- Mount the spring, the vacuum membrane cover, and the lock bolt.

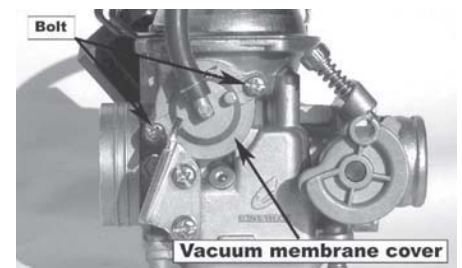
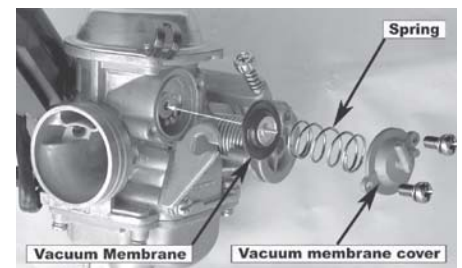

The bottom side of the vacuum membrane should be aligned with the carburetor. The top side should be aligned with the vacuum membrane.

AIR CHECK VALVE

The air check valve starts working under 31mph (50 km/h), and opens the second air inlet to reduce CO₂ displacement.

AIR CHECK VALVE INSTALLATION

Reverse the procedure for removal

When installing, make sure all the connecting pipes are connected properly, and that they are not squeezed, bent, or clogged up.

TRANSMISSION COMPONENTS

STARTING MECHANISM INSPECTION AND SERVICING

The starting mechanism can be divided into two types: kick starting and electric starting.

SPIRAL SPLINE TRANSFERRING STYLE STARTING MECHANISM

The picture shows the structure of the spiral spline transferring style starting mechanism.

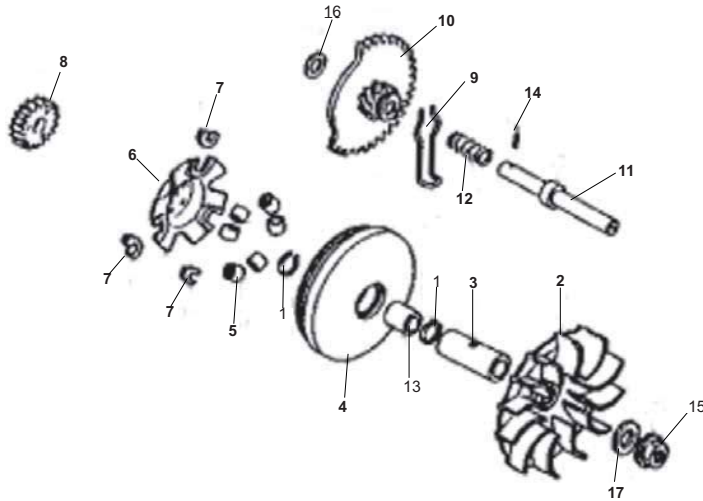

- | | |
|---------------------------------|-----------------------------|
| 1. Clip | 10. Starter idle gear comp. |
| 2. Drive face | 11. Starter idle shaft |
| 3. Drive face boss | 12. Starter idle spring |
| 4. Movable drive face comp. | 13. Face drive collar |
| 5. Weight roller set | 14. Roller |
| 6. Ramp plate | 15. Nut |
| 7. Slide piece | 16. Washer |
| 8. Starting driver pulley | 17. Washer |
| 9. Starter gear friction spring | |

SPIRAL SPLINE TRANSFERRING STYLE STARTING MECHANISM REMOVAL

- Install the crankcase dowel pin and gasket.
- Install the driven belt and the driving plate.
- Install the left crankcase cover and lock tightly.

ELECTRICAL STARTING SYSTEM

STARTER MOTOR

The starter motor is actually a direct current (DC) motor, and its structure is shown in the picture.

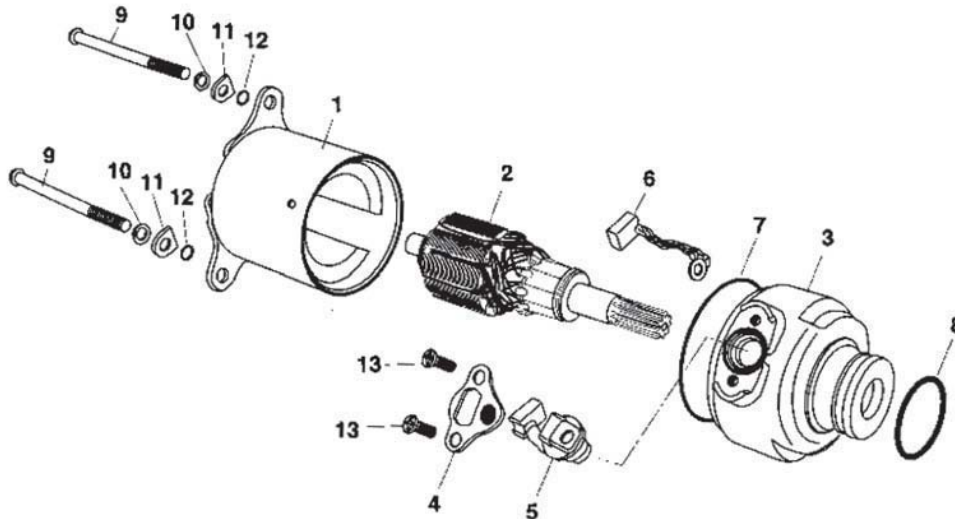

- | | |
|-------------------------------------|-------------------|
| 1. Outer Cover, Motor | 7. O-ring |
| 2. Rotor, Motor | 8. O-ring |
| 3. Base, Carbon Brush | 9. Bolt |
| 4. Plate, Positive Electrode | 10. Spring Washer |
| 5. Carbon Brush, Positive Electrode | 11. Washer |
| 6. Carbon Brush, Negative Electrode | 12. O-ring |
| | 13. Screw |

STARTER MOTOR REMOVAL

Before removal, first shut off the main switch, and disconnect the battery connecting wire. Then press the starting button; at this time the starter motor should not run. Do this to insure safety.

- Remove the starter motor lead wire clamp.
- Remove the starter motor holding bolt, and remove the starter motor.
- Roll up the rubber water-resistance cover, and remove the starter motor joint.
- Remove the motor case bolt, the carbon brush seat, and the motor case, etc.

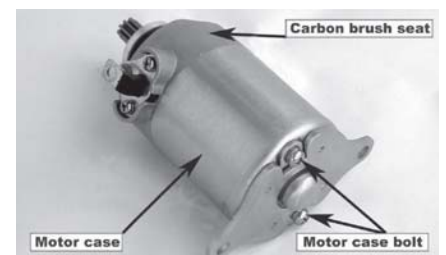
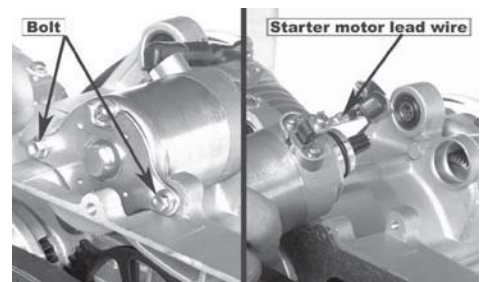

ARMATURE INSPECTION

- Inspect the armature surface for uneven wear, damage or burns (changing color).
- When there are metal shavings attached to the gap of the armature surface, use a cleaning cloth to remove them.

Do not use sandpaper to grind the armature surface, nor wash it in any solvent which can dissolve or damage its insulation.

- Measure the conducting condition of the armature coil according to the picture on the immediate right. It should be conductive.
- Measure the conducting condition between the armature coil and the armature according to the far-right picture. It should be non-conductive. If it's not, it should be replaced.

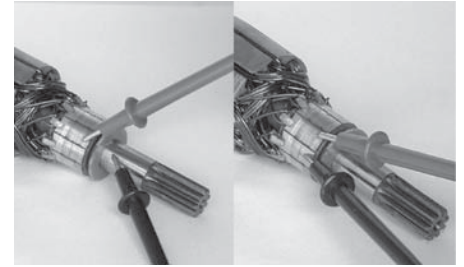
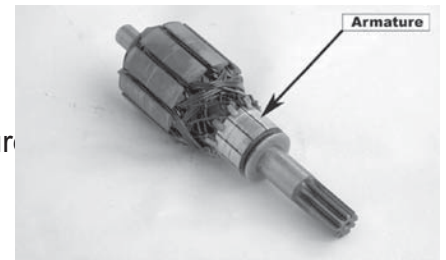

CARBON BRUSH INSPECTION

- Inspect the insulating condition between the connecting wire terminal and the starter motor case. It should be nonconductive.

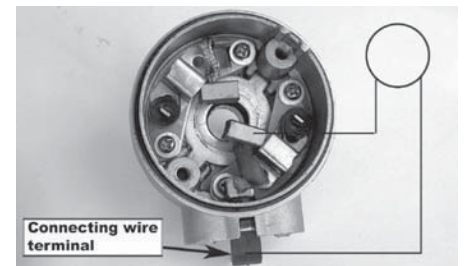

- Inspect the conducting condition between the connecting wire terminal and the carbon brush. It should be conductive. Measure the length of the carbon brush. Replace it if it exceeds service limit.

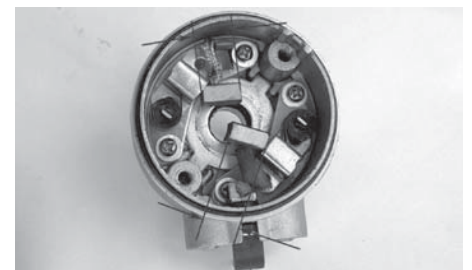

- Measure the insulating condition of the carbon brush bracket. It should be non-conductive; if not, it should be replaced.

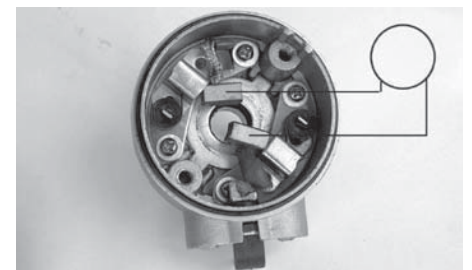

- Inspect the needle bearing in the carbon brush base; it should be able to move smoothly with no play.
- Inspect the dust seal for wear or damage.
- If damaged, it should be replaced.

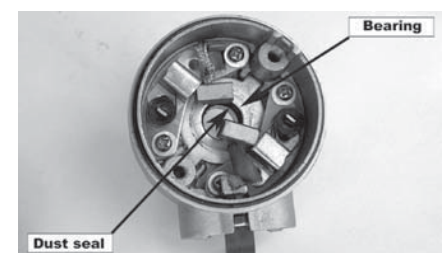

STARTER MOTOR INSTALLATION

- Apply some oil on the dust seal.
- Install the carbon brush on the carbon brush base.
- Apply a little oil on the moving part of the armature ends.
- Put the carbon brush into the bracket, and then install the carbon brush base.

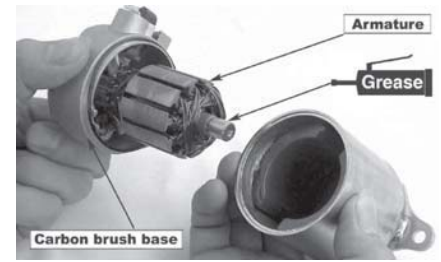

Do not damage the contact area of the carbon brush and the armature. When installing, do not damage the lip of the dust seal.

- Mount the new O-ring on the carbon brush base.
- Install armature into starter motor case, making sure not to damage the carbon brushes.
- Tighten motor case bolts.

Make sure the starter motor case is free of metal particles because it is magnetic.

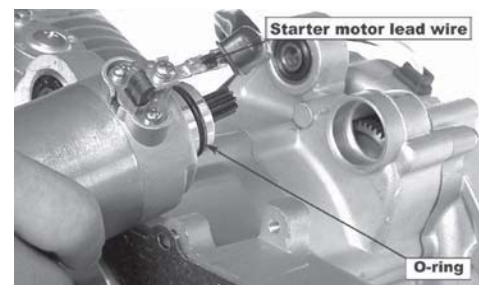

Before installing the starter motor on the vehicle after assembling it, first connect the lead wires and check that the motor is running normally.

- Apply oil on the O-ring, and install the starter motor.
- Tighten holding bolts.



REDUCTION MECHANISM

The picture shows the structure of the reduction mechanism.

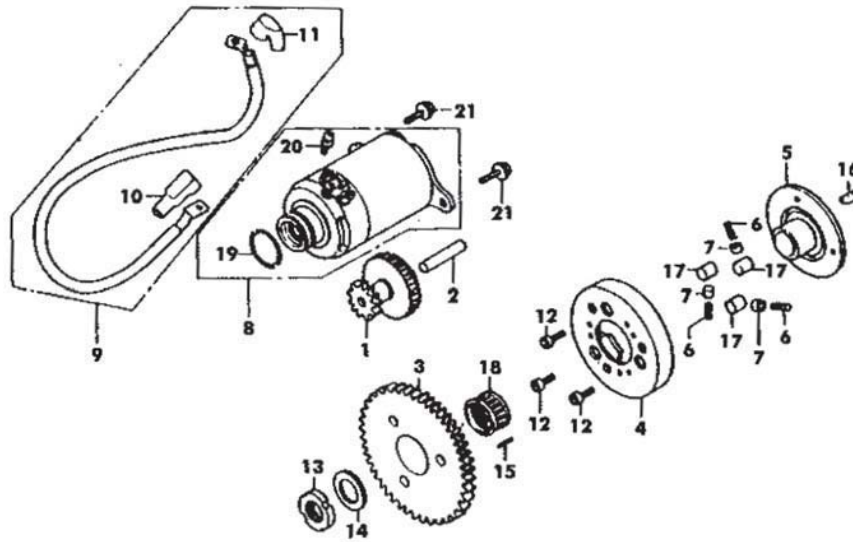

- | | |
|----------------------------------|--------------------|
| 1. Starter reduction gear | 12. Bolt |
| 2. Starter reduction gear shaft | 13. Nut |
| 3. Starting clutch gear comp. | 14. Washer |
| 4. Starting clutch outer comp. | 15. Dowel pin |
| 5. Flange starting clutch | 16. Key woodruff |
| 6. Starting clutch roller spring | 17. Roller |
| 7. Spring holder | 18. Needle bearing |
| 8. Starter motor | 19. O-ring |
| 9. Starter motor lead wire | 20. Screw |
| 10. Clamp | 21. Bolt |
| 11. Clamp | |

REDUCTION GEAR INSPECTION

- Remove the starting clutch.
- Remove the reduction gear to inspect its wearing degree.
- Measure the inner diameter of the reduction gear shaft. It should be replaced when the diameter is more than 10.05mm.
- Measure the outer diameter of the reduction gear shaft. It should be replaced when the diameter is less than 9.94mm.

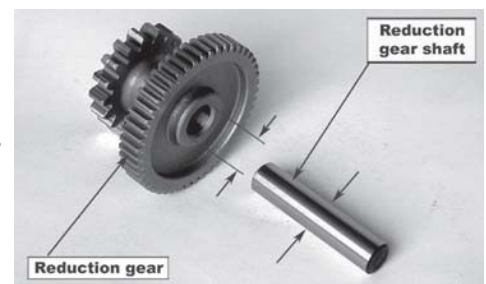

ENGAGING MECHANISM

STARTING CLUTCH REMOVAL

- Remove the right crankcase cover.
- Remove the left crankcase cover.
- Hold the drive face with the universal set wrench.
- Remove the starting clutch fixing nut.



Notice that the thread of the fixing nut should be left-handed rotation.

- Remove the starting clutch (the whole set).

STARTING CLUTCH INSPECTION

- Inspect the movement between the clutch and the driving gear. The driving gear should smoothly turn clockwise, and should not move counterclockwise.



- Inspect the contact surface between the driving gear and the needle bearing for abrasion or other damage. It should be replaced if the surface is damaged.
- Measure the inner diameter of the driving gear. It should be replaced when the diameter is more than 32.06mm.
- Inspect the condition of the needle bearing. It should be replaced if there is any damage.
- Inspect the contact surface between the outer clutch component and the roller for abrasion or other damage.
- Inspect the roller for injury.
- Inspect the spring for distortion.
- If the damage is serious, it should be replaced.

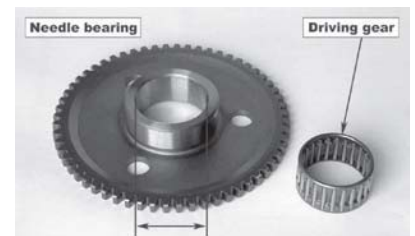

- Measure the inner diameter of the flange clutch. It should be replaced when the diameter is more than 27.94mm.



STARTING CLUTCH INSTALLATION

- Install the spring, the roller and the top pin on the body of the clutch.
- Align the dowel pin on the flange clutch with the hole on the clutch body; then install.
- Apply some thread lock on the outer clutch component bolt and tighten.
- Apply some oil on the needle bearing and the driving gear; then put the outer clutch component on.
- Align the groove of the woodruff key on the crank, and install the starting clutch.
- Apply some oil on the reduction gear and the reduction gear shaft; then install.
- While holding the drive face with the universal wrench, fasten the clutch nut.

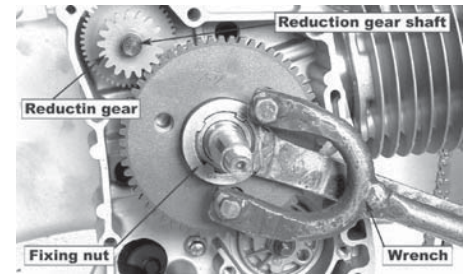
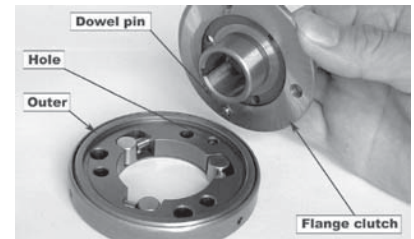

Notice that the thread of the nut should be left-handed rotation.

- Install the right crankcase cover.
- Install the left crankcase cover.

CONTROLLING MECHANISM

STARTER RELAY INSPECTION

- Turn the main switch to the “ON” position. Press down the starting motor button, and listen for a “click” sound. If clicking sound is not heard, follow the below procedures to inspect.
- Inspect to see if the brake switch for conductivity. At this time, turn the main switch on and hold the brake lever.

The battery voltage should be at 12 volts.

- Measure the voltage between the inlet line (the green/yellow line) starting relay and the ground wire of the body. The voltmeter reading should be close to the magnitude of voltage between the two ends of the battery. If not, then the brake switch, its wire or the wire connector is damaged.
- Check the conductivity of the start button. At this time, remove the starting relay inlet line (the green/yellow line).
- Connect the yellow/red line with the ground wire, and press the start button. It should be conductive between the yellow/red line and the ground wire. If it is not conductive, then the start button, its wire, or the wire connector is damaged.

- Check the working condition of the starting relay. At this time, remove the starting relay.
- Connect the C end and the D end of the starting relay with the battery, and the A and B ends with the multimeter.

The battery voltage should be at 12 volts.

At this time the multimeter should indicate a conductive condition, or the starting relay is not good.

BELT DRIVEN CVT MECHANISM INSPECTION AND SERVICING

GENERAL INTRODUCTION

The belt driven CVT mechanism is made up of two belt pulleys (the drive belt pulley and the driven belt pulley) whose diameter can be changed, and a notched driven belt. The driving belt pulley is mounted on the engine crankshaft, and the driven belt pulley connects with the rear driven mechanism.

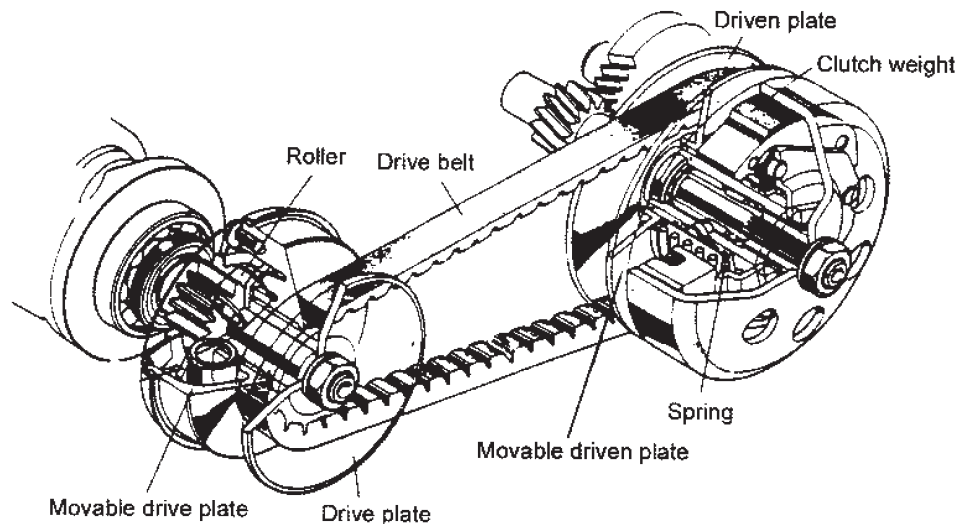

Its basic operational principle is to realize automatic CVT by the diameter changes (the transmission ratio changes) of the driving and driven belt pulley.

When the diameter of the driving belt pulley changes from small to big, proportionally the diameter of the driven belt pulley changes from big to small (because the perimeter of the driven belt is constant). At this time the speed increases. Conversely, the speed decreases when the diameter of the driving belt pulley changes from big to small, and the diameter of the driven belt pulley changes proportionally from small to big.

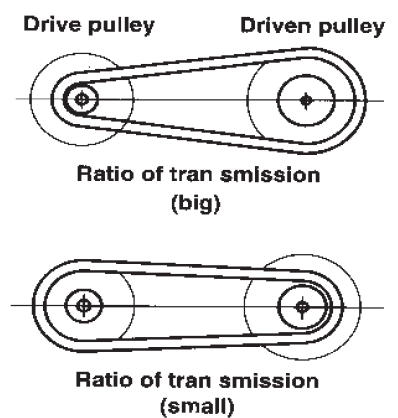

The structure of the driving belt pulley is shown in the picture.

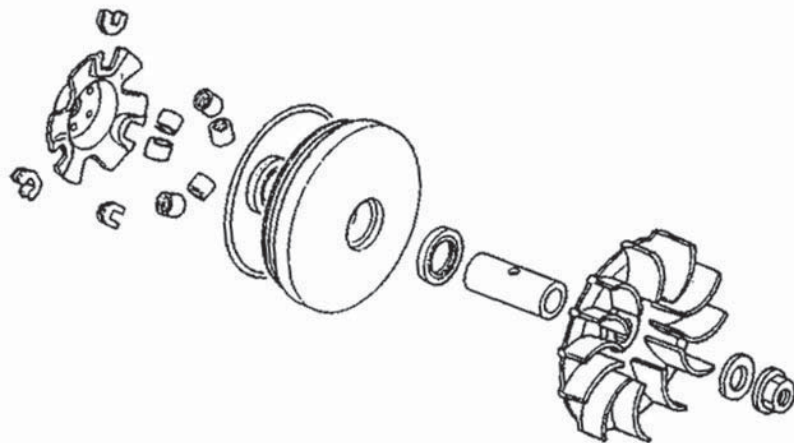

The picture shows the working theory of the driving belt pulley.

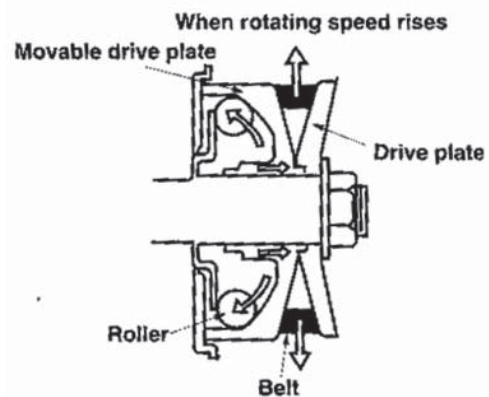

The picture shows the structure of the driven belt pulley. The clutch showed in this picture is the automatic dry centrifugal weight clutch.

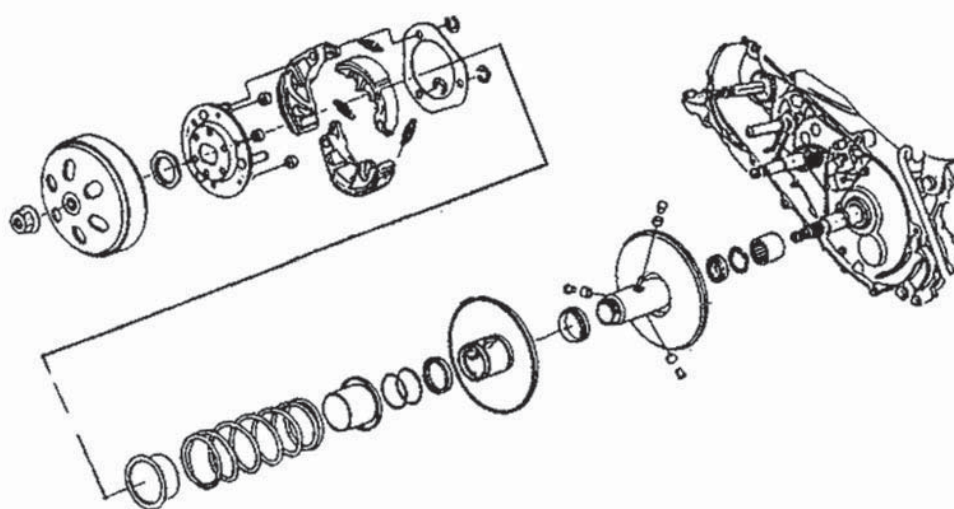

DRIVE BELT PULLEY

DRIVE BELT PULLEY REMOVAL

- Remove the left crankcase air pipe lock bolt.
- Remove the kick starter, and remove the left crankcase fixing bolt. Remove the left crankcase cover. Remove the gasket and the dowel pin.
- While holding the drive plate with a universal wrench, remove the nuts and gasket on the drive plate shaft. Remove the drive plate.
- Remove the driven belt from the drive plate.

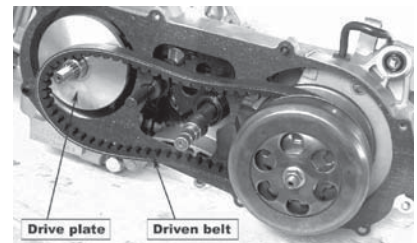
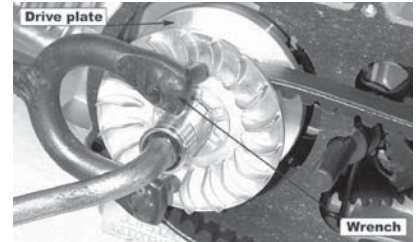

- Remove the movable drive plate (the whole set).

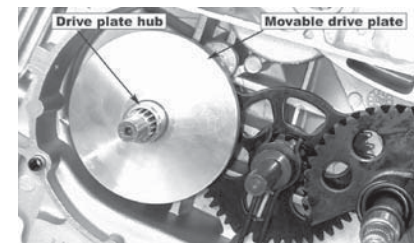

- Remove the ramp plate.

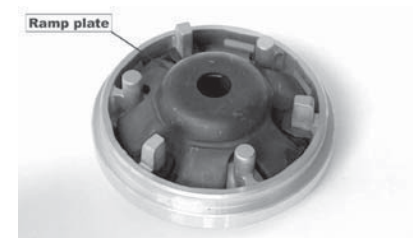

- Remove the centrifugal rollers.



DRIVE BELT PULLEY INSPECTION

- Inspect for abrasion or damage to the centrifugal roller.
- Measure the outer diameter of the centrifugal roller.

Service Limit	17.00mm
----------------------	---------

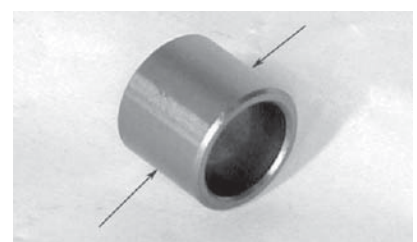

- Measure the inner diameter of the movable drive plate.

Service Limit 24.06mm

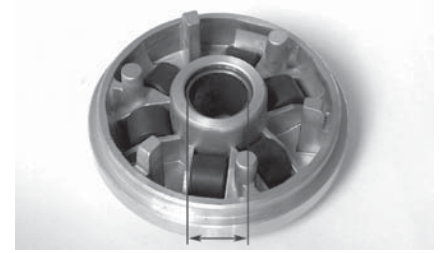

- Inspect if there is any abrasion or damage of the drive plate hub.
- Measure the outer diameter of the drive plate hub's movable surface.

Service Limit 23.94mm

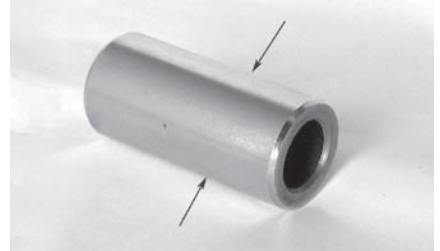

DRIVE BELT PULLEY INSTALLATION

- Apply some grease evenly in the movable drive plate.
- Put the centrifugal rollers into the movable drive plate.

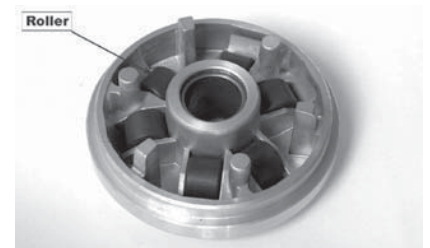

- Install the ramp plate.

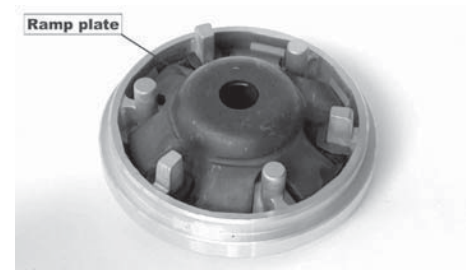

- Put the drive plate hub into the drive plate.

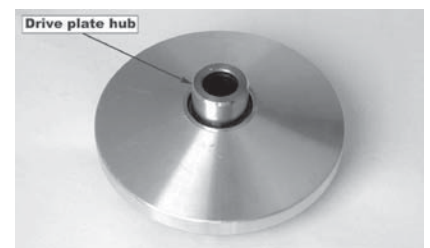

- Install the movable drive plate on the crankshaft.

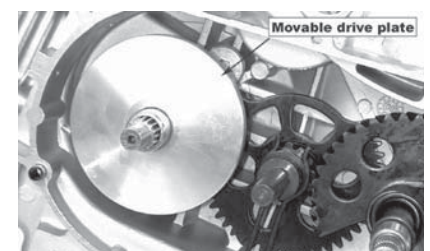

- Enlarge the driven plate belt groove, and mount on the driven belt. Mount the other end of the driven belt on the drive plate hub.
- Mount the drive plate, the drive plate washer, and nut.

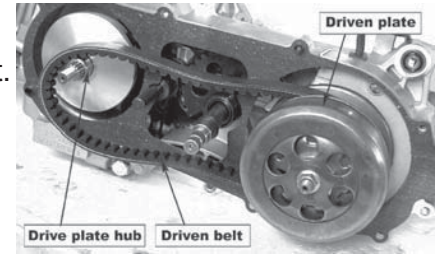

- Hold the drive plate with a multiuse holder to make it unmovable.
- At the same time fasten the nut on the shaft.

Do not allow any grease or oil to get on the surface of the movable drive plate and the driven belt.

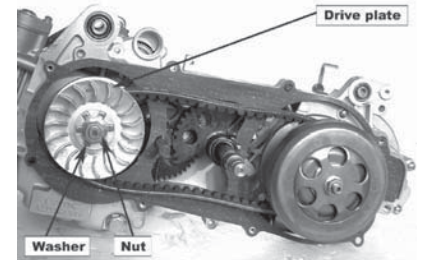

CLUTCH

CLUTCH REMOVAL

- Remove the left crankcase cover.
- Remove the drive plate and the driven belt.
- Hold the clutch friction plate with a multiuse holder, and remove the nut.
- Remove the clutch friction plate.

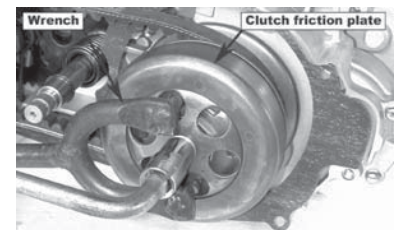

CLUTCH INSPECTION

- Inspect for any abrasion or damage on the clutch friction plate.
- Measure the inner diameter of the clutch friction plate.



Service Limit	125.5mm
----------------------	---------

- Inspect for any abrasion or damage of the clutch centrifugal weigh friction piece.
- Measure the thickness of the clutch centrifugal weigh friction piece.

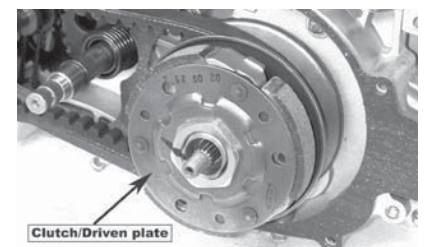

Service Limit	1.5mm
----------------------	-------

CLUTCH DISASSEMBLING

- If the centrifugal weight set needs to be replaced, you must disassemble the clutch.

When the friction piece is worn, replace it and the centrifugal weight set.

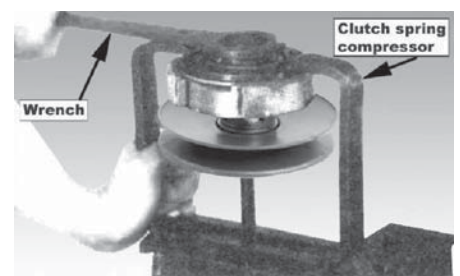

- Remove the clutch friction plate.
- Remove the whole clutch/driven plate set.
- While compressing the driven pulley spring with the clutch spring compressor, remove the nut on the shaft.
- Disassemble the clutch with the driven pulley.
- Remove the circlip, and remove the connecting piece.
- Remove the clutch centrifugal weight set and the spring.



CLUTCH INSTALLATION

- Mount the clutch damper rubber onto the drive plate pin.
- Mount the new clutch weight set and spring on the drive plate.
- Install the connecting piece, the circlip, and the bottom plate.
- Finally reverse the removal procedure for installation.

To avoid damaging the spring when assembling the clutch and the driven plate, you must use a clutch spring compressor. The driven pulley must be free of grease.

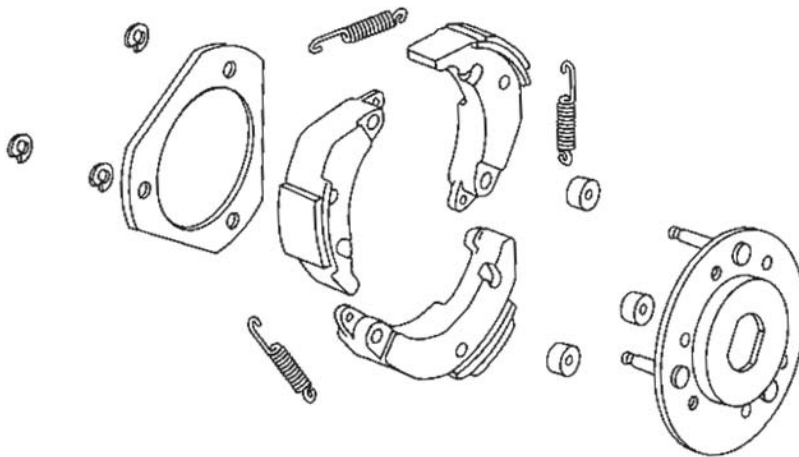

DRIVEN BELT PULLEY

DRIVEN BELT PULLEY REMOVAL

- After removing the clutch friction plate, remove the guide pin, the roller and the movable driven plate.

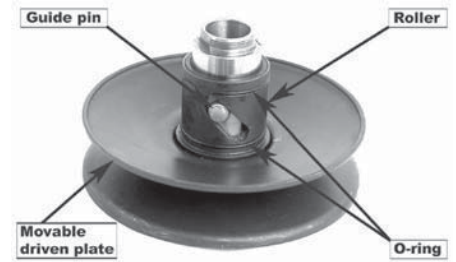

- Remove the oil seal on the movable driven plate.



DRIVEN BELT PULLEY INSPECTION

- Measure the free length of the driven belt pulley spring.

Service Limit	163.7mm
----------------------	---------

- Inspect for any abrasion or damage on the driven plate.

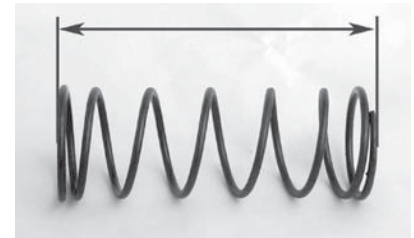

- Measure the outer diameter of the driven plate pulley hub.

Service Limit	33.94mm
----------------------	---------



- Inspect for any abrasion or damage of the movable driven plate.

Service Limit	34.06mm
----------------------	---------



- Inspect the groove of the guide pin for wear.

DRIVEN PLATE BEARING REPLACEMENT

If the driven plate needle bearing or the ball bearing are loose, damaged, or make unusual sounds, they should be replaced.

- Remove the needle bearing from the driven plate.

The removed bearing cannot be reused.

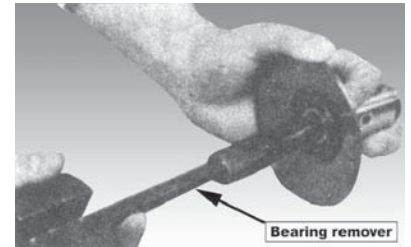

- Remove the circlip from the driven plate.
- Drive the ball bearing out.

The removed bearing cannot be reused.

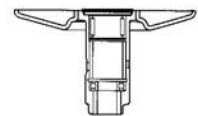
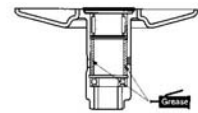
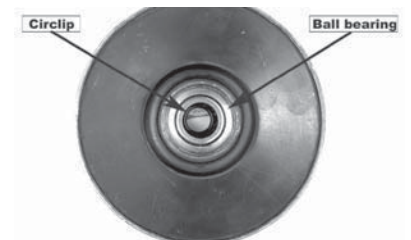

- Apply some grease on the new ball bearing.
- Drive the ball bearing into the driven plate with its front face upwards.
- Mount the circlip.
- Apply grease evenly on the inner wall of the driven plate.

Use the prescribed grease.

- Drive in the new needle bearing with its mark upwards.

Use the specific tool.

- Apply grease around the bearing.

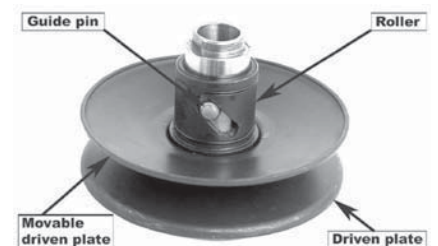

DRIVEN BELT PULLEY INSTALLATION

- Remove the grease on the driven plate.
- Mount the oil seal.
- Apply a little grease on the O-ring.
- Mount the movable driven plate into the driven plate.
- After applying some grease on the roller and the guide pin, mount them into the driven plate hole.
- Install the oil seal collar.
- Remove the excessive grease.

Do not get grease on the movable faces of the driven plate.

- Assemble with the clutch and install on the left crankcase.



TRANSMISSION BELT

TRANSMISSION BELT INSPECTION

- Remove the left crankcase cover.
- Inspect the transmission belt for cracking and wear.
- Measure the width of the belt.

Service Limit 19.0mm

- Replace the belt if its width is less than the above limit.

When replacing, you must use the OEM part for correct fit.

See the drive pulley removal and installation procedure for the replacement.

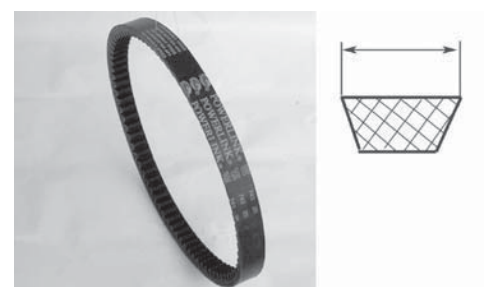
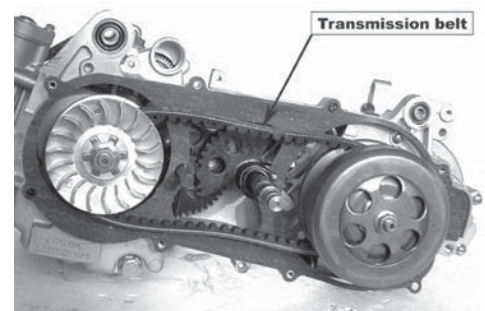

REAR TRANSMISSION MECHANISM INSPECTION AND SERVICING

The structure of the rear transmission mechanism is shown in the following picture.

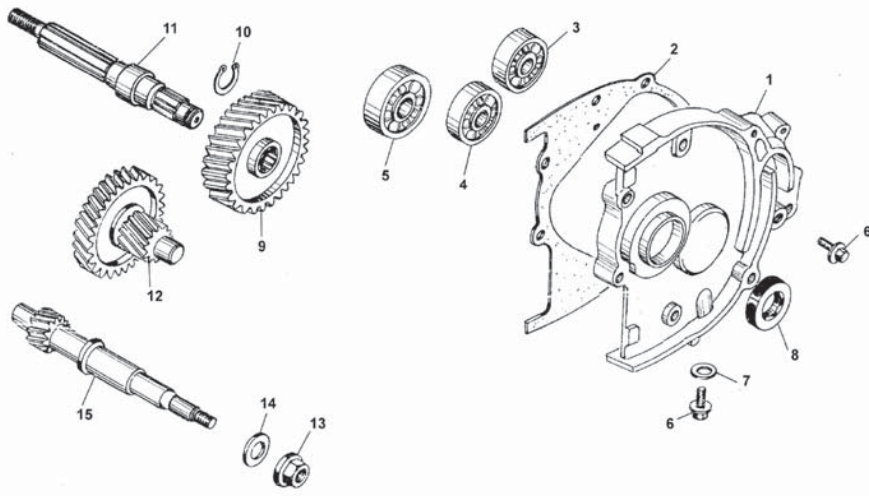

TRANSMISSION CASE OIL REPLACEMENT

TRANSMISSION CASE OIL INSPECTION

When inspecting the oil level of the transmission case, use a flat surface and keep the body level.

- Check for oil leakage around the transmission case.
- After the engine stops, remove the transmission case oil level bolt.
- Observe the oil level. The oil level should be parallel with the observing hole.
- When the oil level is too low, add until the oil flows from the level screw.

Always refill with the specified oil.

- Mount the transmission case oil level bolt and the washer.

Inspect the bolt oil seal to see if it is damaged.

TRANSMISSION CASE OIL REPLACEMENT

- Remove the transmission case oil level bolt.
- Remove the oil drain bolt to drain the oil.
- Mount the drain bolt and its oil seal and fasten.

- Supply the oil with the prescribed specification and oil level.
- Mount the level bolt.
- After replacing the oil, inspect for any oil leaks.

TRANSMISSION CASE

TRANSMISSION CASE REMOVAL

- Remove the driven belt pulley.
- Drain out the oil in the transmission case.
- Remove the drive sprocket.
- Remove the bolt, and remove the transmission case cover.
- Remove the gasket and the dowel pin.
- Remove the final gear, the final gear shaft, and remove the sub shaft/sub shaft gear.

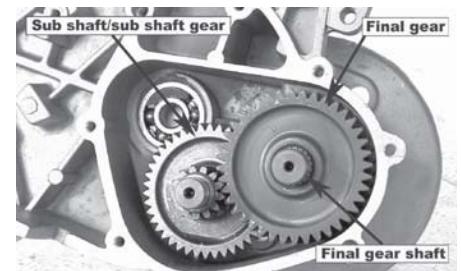
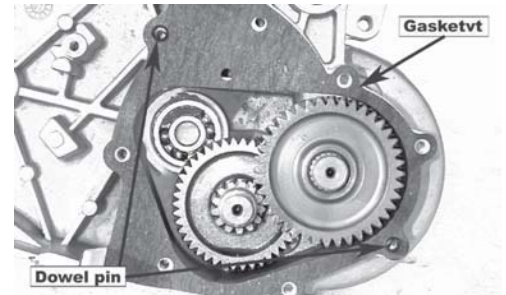

TRANSMISSION CASE GEAR INSPECTION

- Check the sub shaft/sub shaft gear for wear and other damage.



- Check if the final gear and the final gear shaft for wear and other damage.



BEARING ON THE TRANSMISSION CASE COVER REPLACEMENT

When removing or installing the bearing on the transmission case cover, you must use the specific tool shown in the picture.

- Press the driven belt pulley shaft out of the transmission cover.

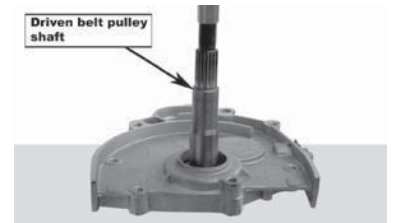

- Remove the oil seal and drive out the bearing.

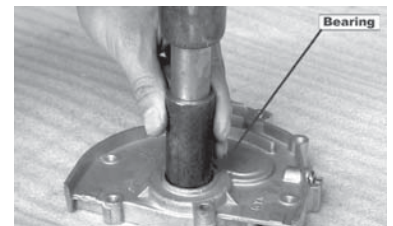

- Remove the final gear shaft bearing.

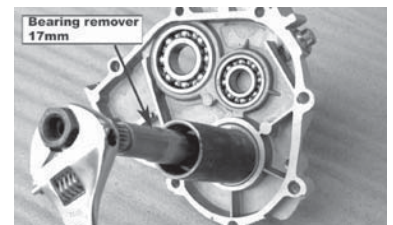

- Remove the sub shaft bearing.

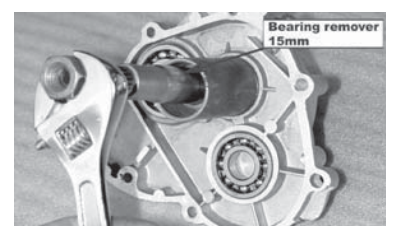

- Drive in the new final gear shaft and bearing.

When driving in the final gear shaft bearing, keep the bearing parallel. The same is required when installing the sub shaft bearing and the driven pulley shaft bearing.

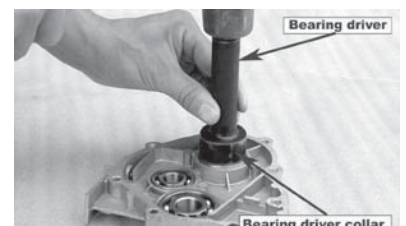

- Drive in the new sub shaft bearing.

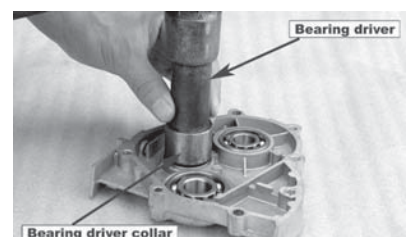

- Drive in the driven pulley shaft bearing.

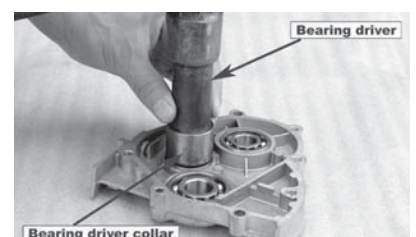

BEARING ON THE LEFT CRANKCASE BODY REPLACEMENT

When removing or installing the bearing on the left crankcase body, you must use the specific tool.

- Inspect the bearing and oil seal on the left crankcase for wear or damage. If it is damaged, it must then be replaced.
- Remove the oil seal.
- Drive out the final gear shaft bearing.
- Remove the sub shaft bearing.
- Remove the driven belt pulley shaft bearing.
- Drive in the new driven belt pulley shaft bearing.
- Drive in the new sub shaft bearing.
- Drive in the new final gear shaft bearing.

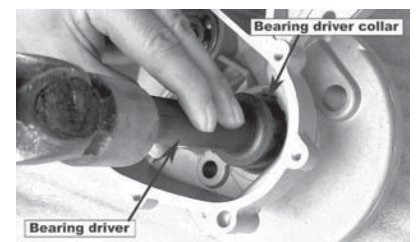
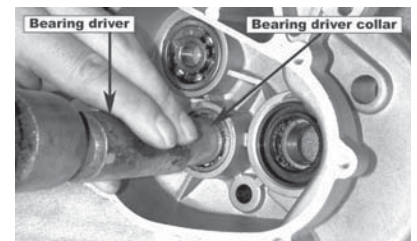
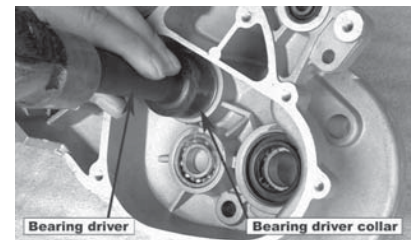
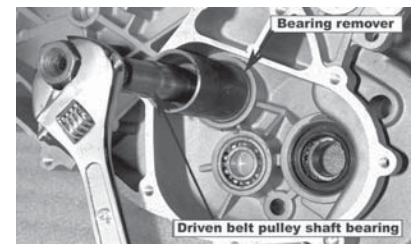
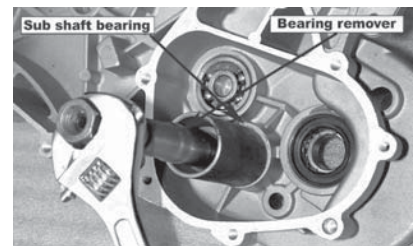
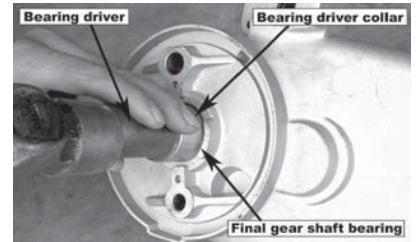

- Install the driven belt pulley shaft on the transmission case cover.

- Drive in the transmission case cover oil seal.

- Mount the sub shaft/sub shaft gear and the final gear shaft into the left crankcase.

- Mount the final gear on the final gear shaft.

- Install the new dowel pin and gasket.
- Install the transmission case cover and bolt.

- Mount the driven pulley and the clutch set.

- Mount the drive pulley, the transmission belt, and the left crankcase cover.
- Fill the transmission case with oil.

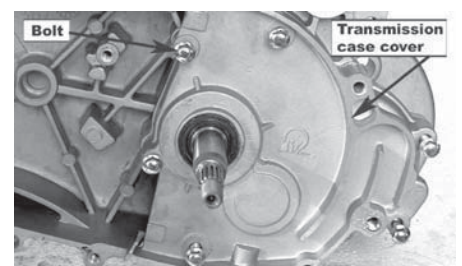
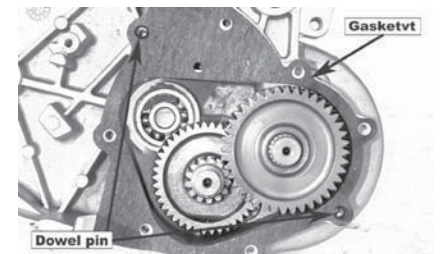
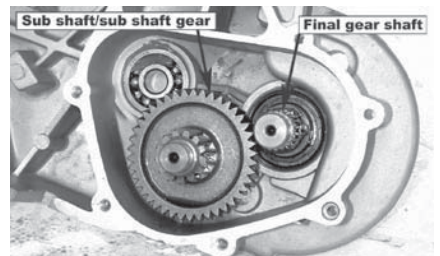
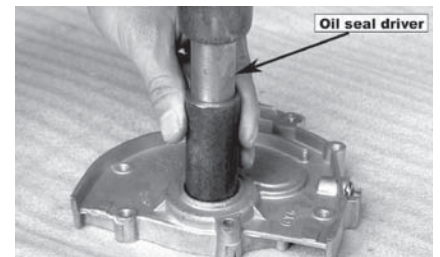
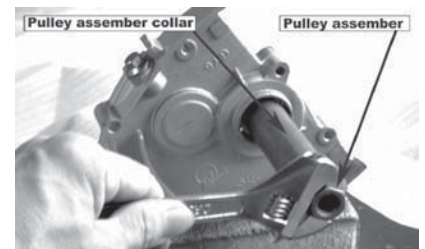
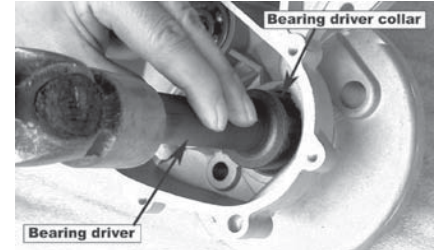

ELECTRICAL SYSTEM

CHARGING SYSTEM INSPECTION AND SERVICING

ELECTRIC LEAKAGE TESTING

- Turn the main switch to the “OFF” position.
- Disconnect the negative ground wire from the battery.
- Connect the positive end of the ammeter with the negative end of the battery.
- Connect the negative end of the ammeter with the ground wire.
- Test the electric leakage. In general, the number should be less than 1 m A; if it is unusual, check for is a short circuit of the main switch and the main wiring.

CHARGING STATUS INSPECTION

- Install the fully charged battery.
- Connect the voltmeter between the binding posts of the battery.
- Remove the fuse, and connect the ammeter with two ends of the fuse.
- Connect the tachometer to the engine (it's not needed when there is rpm indicator on the vehicle).
- Start the engine, and accelerate slowly. Measure the charging voltage and current.

Charging voltage (V)	13.5 ~ 15.5
Charging current (A)	0.5

*Measuring condition: 5000 r/min

If the voltage is not in the range of the above-specified value, please inspect the voltage regulator.

BATTERY

The battery is an important component of the electric system. The battery used on the vehicle is a maintenance-free battery. For long periods of storage, the battery will discharge. It should be charged every 3 months. After 2 ~3 years of regular usage, the capacity of the battery will lessen and will need changing. Replace with the same type of battery.

BATTERY REMOVAL

Shut down the main switch to make sure no electric current goes through the vehicle.

- Disconnect the negative battery lead wire first.
- Disconnect the positive battery.

The disconnecting order cannot be reversed. When disconnecting the positive cable, do not touch the body of the vehicle with the removal tool, or it will short circuit and ignite gas that will damage the battery.

BATTERY INSTALLATION

Connect the positive cable first, then connect the negative cable.

BATTERY OPEN-CIRCUIT VOLTAGE INSPECTION

Disconnect the cable on the battery terminals.

Disconnect the negative pole first, then the positive pole.

Measure the voltage between the two poles of the battery.

Full charging	13.1V
Under charging	12.3V

BATTERY CHARGING

- Lift the battery out of the vehicle.
- Connect the positive pole of the charger with the positive pole of the battery.
- Connect the negative pole of the charger with the negative pole of the battery.
- Charge the battery for the charging time marked on the battery.

Unless it is urgent, do not use fast charging. There should be no smoking or open fire near the battery when charging. At the beginning or the end of charging, turn off the charger first, in order to avoid the connecting part arcing.

Measure the voltage 30 minutes after charging is finished. It should reach the specified value, or recharging is needed.

Charging Current	Normal	0.7 A
	Fast	3.0 A
Charging Time	Normal	5-10 hours
	Fast	30 minutes
Charging Result	Open-circuit voltage $\geq 12.8V$	

PRIMARY COIL

The picture shows the structure of a common generator.

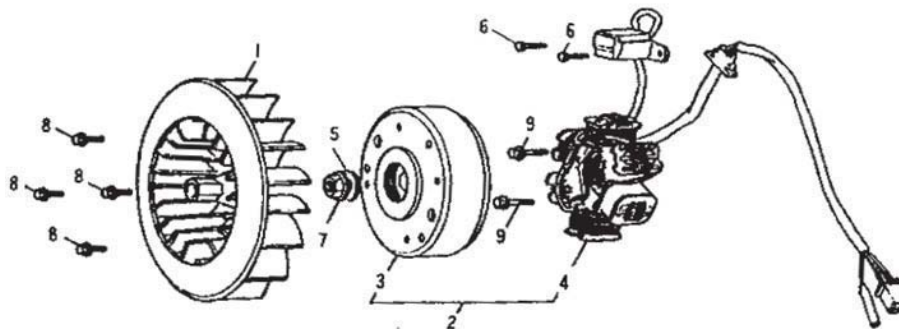

- | | |
|-----------------------|---------|
| 1. Cooling Fan | 6. Bolt |
| 2. Generator assembly | 7. Nut |
| 3. Flywheel comp. | 8. Bolt |
| 4. Stator comp. | 9. Bolt |
| 5. Washer | |

PRIMARY COIL INSPECTION

When the inspection work is done on the engine there is no need to remove the generator.

- Remove the 4- core connector of the generator.
- Measure the resistance value between the white wires of the generator and connecting wire of the vehicle body.

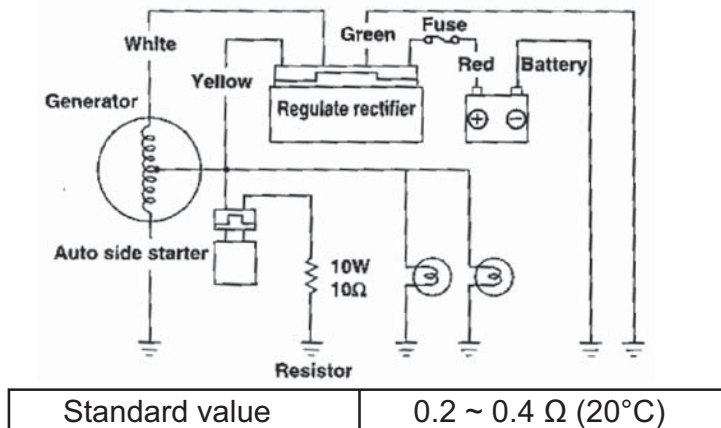

When the actual value is more than the standard value, the coil should be replaced.

GENERATOR REMOVAL AND INSPECTION

GENERATOR REMOVAL

- Remove the cooling fan cover bolt and screw.
- Remove the cooling fan cover.
- Remove the cooling fan bolt, and remove the cooling fan.
- While holding the flywheel with a universal holding wrench, remove the flywheel nut.
- Remove the flywheel with a flywheel puller, and remove the solid key.

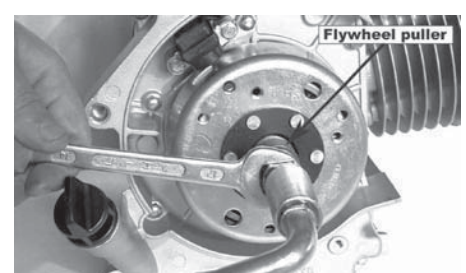
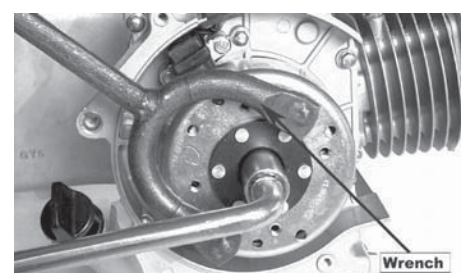
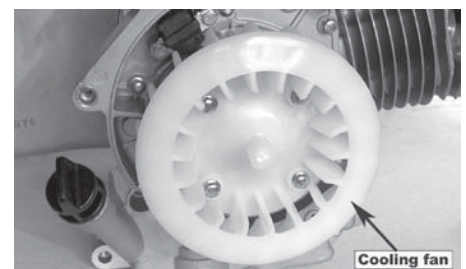

- Remove the generator wire connector.
- Remove the generator wire holder.
- Remove the generator coil bolt.
- Remove the generator wire rubber bushing from the right crankcase.
- Remove the coil set.

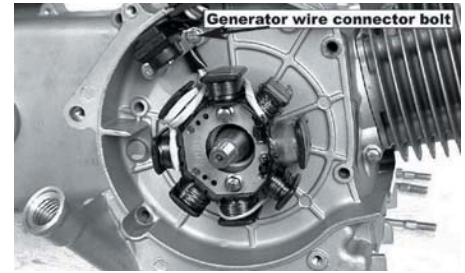

Do not damage the coil when removing.

GENERATOR INSTALLATION

Reverse the removal procedure for installation.

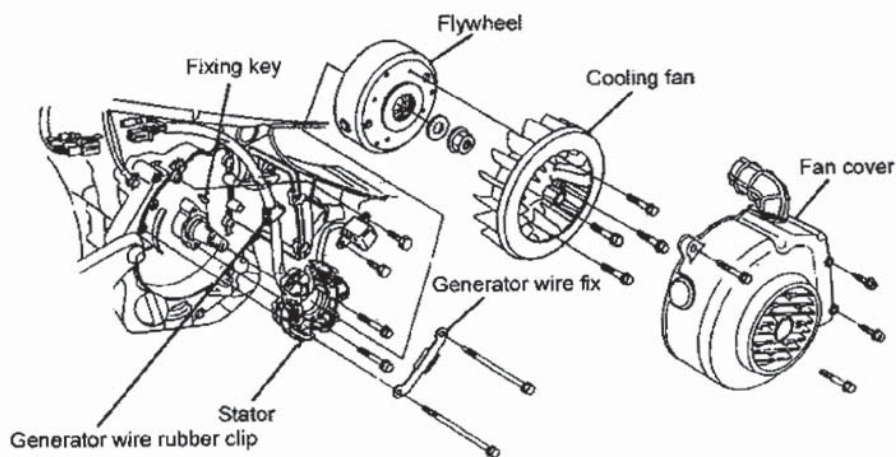

When installing the flywheel, make sure there are no metal pieces, such as bolts or nuts, attached to the inner wall of the flywheel. After the installation is finished, start the engine to inspect and adjust the ignition timing.

REGULATE RECTIFIER

MAIN WIRING – SUB ELECTRIC CIRCUIT CONDITION INSPECTION

Perform the voltage regulate rectifier inspection procedure in two steps: First inspect the main wiring – sub electric condition, and then inspect the voltage regulator. Second, inspect only when engine is cold.

- Remove the 4-core connector of the regulate rectifier.
- Measure the conducting status between the main wiring terminals according to the previous wiring diagram.

Connecting type	Normal condition
Battery (the red wire) – Vehicle body	Battery voltage value
Connecting wire (the green wire) – Vehicle body	Conductive
Lighting wire (the yellow wire) – Vehicle body (remove the resistor, side auto starter plug, and turn the lighting switch to OFF)	Generally is 0.1 ~0.8 Ω
Charging wire (the white wire)- Vehicle body	Generally is 0.2 ~ 2.0Ω

	W (White)	Y (Yellow)	R (Red)	G (Green)
W (White)		∞	3 ~ 100KΩ	∞
Y (Yellow)	∞		∞	5 ~ 100KΩ
R (Red)	∞	∞		∞
G (Green)	∞	5 ~ 100KΩ	∞	

REGULATE RECTIFIER INSPECTION

When the main wiring – sub electric circuit condition is normal, inspect the regulate rectifier.

- Check that the regulate rectifier plug contacts well.
- Measure the resistance value between every regulate rectifier terminal.
- If the resistance value between the terminals is unusual, replace the regulate rectifier.

RESISTOR

RESISTOR RESISTANCE VALUE MEASUREMENT

Measure the resistance value between the resistor wire and the vehicle body. It is normal when the actual value is in the range of $\pm 1\Omega$ value marked on the diagram or the resistor. If not, it should be replaced.

IGNITION SYSTEM INSPECTION AND SERVICING

The circuit working principle is shown in the picture.

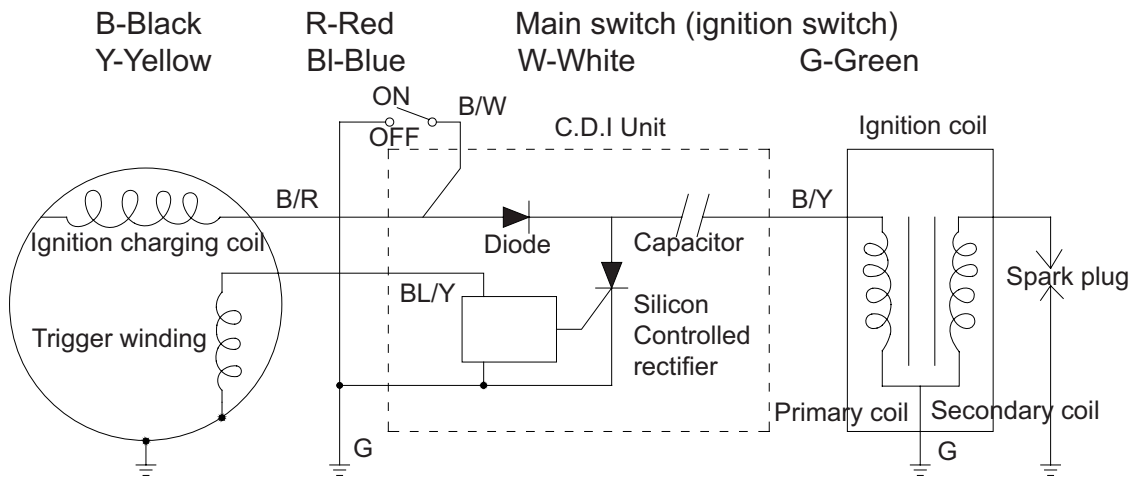

IGNITION TIME INSPECTION

The CDI ignition system has already been adjusted in the factory, so there is no need to readjust it. If inspecting ignition function is necessary, use the following steps to inspect ignition timing.

- Remove the ignition timing hole cover (or remove the fan cover).
- Rotate the generator rotor, and align the “F” mark on the rotor with the crankcase timing ignition mark.
- Clip the ignition timing indicator light wire clip on the high- voltage end of the ignition coil.
- Start the engine and let it idle. At this time, observe if the mark on the crankcase aligns with the “F” mark on the rotor. A difference between $\pm 3^\circ$ indicates correct ignition timing; on the contrary, if it is more than $\pm 3^\circ$, the timing should be adjusted.
- Slowly increase the engine rpm (when the 150 model increases to 5000 r/min), at this time, if the mark on the crankcase aligns with the rotor ignition advance angle mark, the advance angle device is good; if not, it should be adjusted or replaced.
- When adjusting, the trigger winding can be loosened to adjust the angle between it and the ignition charging coil to adjust the ignition time.

IGNITION SYSTEM INSPECTION

- When the spark plug does not spark, first inspect the wires. If the connecting part is loose, or the contacts are bad, etc., follow the electric circuit and use the method of measuring the voltage of every point to determine the trouble. Please refer to the previous picture for the following inspection.
- Remove the old spark plug. Install a new one, if plug is bad.

It is important that every electric circuit wire connects correctly.
It is important that the cylinder compression pressure is normal.

- Connect the negative end of the multimeter with the positive connecting iron of the primary ignition coil (black / yellow wire).
- Press the starting button or use the kick-starter, and read the voltage value on the multimeter. The highest voltage value should be above 112V.

When measuring the voltage, do not touch the metal part of the multimeter with finger, or an electric shock can occur.

- Remove the 4-core and 2-core connectors of the CDI component.
- Connect the positive end of the multimeter with the ignition charging coil (black/red wire end) of the 2-core connector, and the negative end with the ground wire end (green end) of the 4-core connector.
- Press the starting button, or use the kick-starter, and measure the highest voltage of the ignition charging coil. It should be more than 122V.
- When the highest measured voltage of the ignition charging coil is not normal, then disconnect the generator connector to take further measurements.
- If it is measured that the CDI component end is abnormal, and however, the terminal voltage of the generator is normal, then there is a bad wire or bad connection.
- When both are not normal, then the problem is a bad ignition charging coil.
- Remove the 4-core and 2-core of the CDI component.
- Connect the positive end of the multimeter with the trigger winding (green/red wire terminal) on the 4-core connector, and the negative end with the green wire terminal on the 4-core connector.
- Press the starting button, or kickstarter, and measure the highest voltage of the trigger winding, which should be more than 2.1V.
- When the highest measured voltage of the trigger winding is not normal, then remove the generator connector and take further measurements.
- If the measured terminal voltage of the CDI component is not normal and the generator terminal voltage is normal, then there is a bad wire or bad connection.
- If both are not normal, then the problem is a bad trigger winding.

IGNITION CHARGING COIL

- Remove the connector of the ignition charging coil wire.
- Measure the resistance value between the ignition charging coil (black/red wire) and the body ground wire.

Standard Value	300 ~1000 Ω (20°C)
-----------------------	---------------------------

When the actual value is more than the standard value, it should be replaced.

TRIGGER WINDING

- Remove the connector of the trigger winding wire.
- Measure the resistance value between the trigger winding (green/red wire) and the body ground wire.

Standard Value	40 ~300 Ω (20°C)
-----------------------	-------------------------

When the actual value is more than the standard value, it should be replaced.

CDI COMPONENT

The CDI component inspection is similar to the regular inspection. The CDI component inspection is also divided into two steps: First inspect every wiring, winding or coil connected with CDI, then inspect the CDI component.

REMOVE THE CDI COMPONENT.

- Check the connector for looseness or erosion.
- Inspect the conduction and the resistance value of the main switch, the ignition charging coil, the trigger winding, and the ignition coil. When the main switch is in “OFF” position, it should be conducted. The resistance value of every coil should be the standard value.
- Inspect the resistance value between every CDI component terminal. If the actual value is not in the range of the value in the chart, then the CDI component is faulty.

CDI COMPONENT

	SW (B/W)	EXT (B/R)	PC (G/R)	E (G or G/W)	IGN (B/Y)
SW (B/W)		100 ~ ∞	50 ~ ∞	100 ~ ∞	∞
EXT (B/R)	0.5 ~ 50		100 ~ ∞	∞	∞
PC (G/R)	10 ~ 1000	10 ~ 1000		1 ~ 100	∞
E (G or G/W)	0.5 ~ 50	0.5 ~ 50	1 ~ 10		∞
IGN (B/Y)	∞	∞	∞	∞	

B- Black

W- White

R-Red

G-Green

Y- Yellow

The CDI component can also be inspected and measured with the CDI testing instrument.

Please carefully read the instrument specification to know how to properly operate.

- Connect CDI component with the special wire of the testing instrument.
- Observe the spark condition on the instrument when the switch is turned on different positions (OFF, P, EXT, ON1, ON2)

IGNITION COIL

IGNITION COIL REMOVAL

- Remove the spark plug cap.
- Remove the primary ignition coil wire.
- Remove the ignition coil-positioning bolt, and remove the ignition coil.

IGNITION COIL INSTALLATION

- Reverse the removal procedure for installation.

When installing, connect the black/yellow wire of the primary ignition coil with the black/yellow connector of CDI, and the green wire with the green connector of the CDI.

PRIMARY IGNITION COIL INSPECTION

Standard Value	0.1 ~ 1.0K Ω (20°C)
-----------------------	----------------------------

If the resistance value is ∞ , it indicates the coil is bad and should be replaced.

SECONDARY IGNITION COIL INSPECTION

Install the spark plug cap, and measure the resistance value of the secondary ignition coil.

Standard Value	7 ~ 9K Ω (20°C)
-----------------------	------------------------

If the resistance value is in the standard range, it is good; however, ∞ indicates the coil is bad.

Remove the spark plug cap, and measure the resistance value of the secondary ignition coil.

Standard Value	2 ~ 4K Ω (20°C)
-----------------------	------------------------

If the resistance value is in the standard range, indicates it is good; however, ∞ indicates the coil is bad.

The ignition coil also can be inspected and measured with the ignition testing instrument.

Please operate properly according to the instructions.

Set the measuring switch of the ignition coil on the 1.2V position, and connect the ignition coil.

Turn the switch of the testing instrument to the "ON" position. Observe the spark and inspect the spark situation of the ignition coil. If it is a normal consistent spark, it is good; if the spark does not flash consistently, it is not good.

SPARK PLUG

- Clean the carbon around the spark plug to prevent it from dropping into the cylinder. Remove the spark plug.

When installing, connect the black/yellow wire of the primary ignition coil with the black/yellow connector of CDI, and the green wire with the green connector of CDI.

- Clean the filth and carbon accumulation on the spark plug with a steel brush or a blade.
- Inspect the spark plug gap; in general it should be about 0.6 ~ 0.7mm.
- When the carbon accumulation and wear of the spark plug are too severe, replace the spark plug. Replace with the spark plug of the same specification.

CHASSIS

REAR AXLE REMOVAL

- Disassemble RR. wheel.
- Remove the cotter pins on axle nut, RR. wheel.
- Remove the axle nut, RR. wheel.
- Block up rear end of the machine.
- Remove rear wheel and hub assembly by sliding splines off of axle.
- Remove the chain.
- Loosen nuts on bearing carrier and remove bolts.
- Remove axle and bearing carriers as a unit.



REAR SWINGARM

Note: Swingarm, axle and motor can be removed as a unit if needed.

- Remove rear shock.
- Remove rear brake caliper and set aside.
- Do not remove brake hose!
- Unplug brake light wiring from the electrical box.
- Remove throttle cable.
- Remove bolts from swingarm pivot.
- Check buffer rubber Bushing for wear. If wear is present on bushing, it should be replaced.



FRONT & REAR SHOCKS

- The front and rear shocks are oil dampened units.
- They are non rebuildable.
- If any oil seepage is noticed the shock should be replaced.

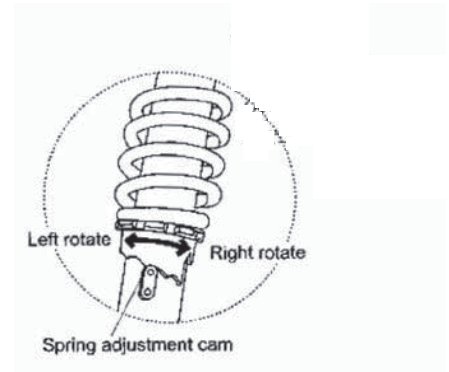

ADJUSTMENT OF FRONT & REAR SHOCK

There are 5 positions for you to choose on each shock. The default position is set by the manufacturer in the middle (the third position).

Please use a round nut wrench as you adjust the position. The tension of the shock spring increases as you turn to the left and decreases as you turn to the right.

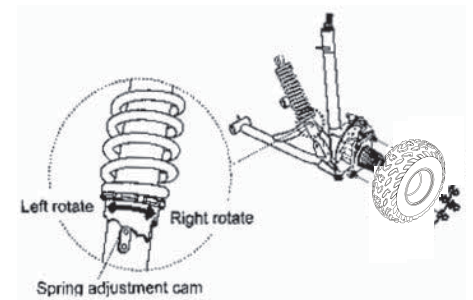

FRONT WHEEL REPLACEMENT

Do not disassemble the castle nuts when you replace the front wheels.

It is only necessary to tighten the nuts so that the wheel turns freely on the axle with minimum end play. Please tighten the nuts after replacing the wheels.

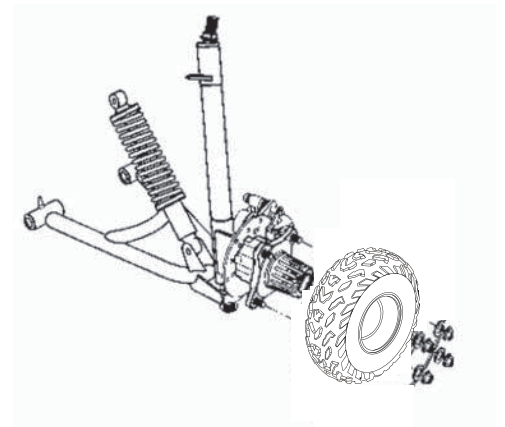

FRONT HUBS

- Check seals for rips or tears and replace if any exist.
- Remove bearings with a punch from the opposite side.
- Inspect bearings for ease of movement. If bearings are dirty or muddy, wash them in cleaning solvent and spin with your finger. Never spin them with compressed air.
- Apply an ample amount of grease to the bearing and reinstall with a bearing tool, making sure it goes in straight. If the bearing is not straight, damage to the hub can occur.
- Install seals into hub. It is recommended to apply a small amount of grease to the lip of the seal. If the retention spring is in bad shape, replace the seal with a new one.

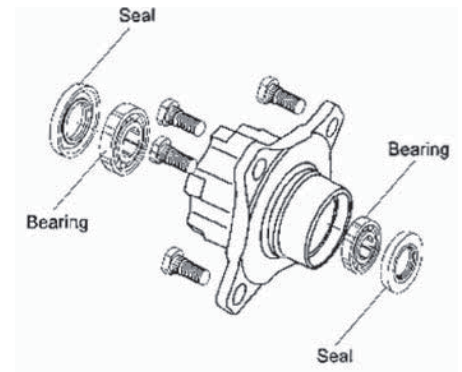

SEAT

- Remove all the nuts and bolts underneath the seat rail.
- Remove seat.

STEERING SHAFT

- Remove nuts, steering block and grease inside of steering block periodically.
- Loosen steering shaft, clamp nut and steering gear box.
- Remove steering shaft.

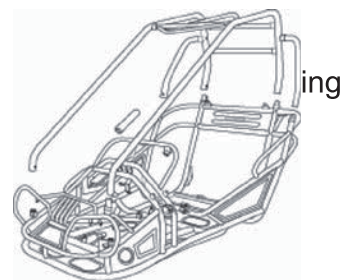

STEERING GEAR BOX AND BALL HEAD AND STEERING GEAR BOX

- Remove four bolts on LH & RH clamp nut and steering gear box.
- Remove and check ball head dust cover and steering gear box for wear.
- Check steering cover on sides of steering gear box and grease the ball head.
- Fills teering gear box with grease after cleaning the dust. Replace the ball joint if it is loose or not smooth.

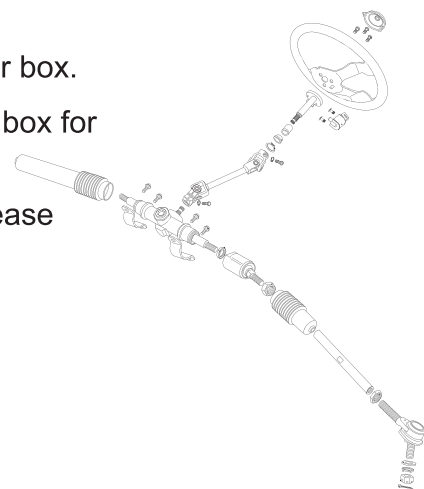

THROTTLE & BRAKE PEDAL

- Remove throttle, throttle pedal and axle nut, check for signs of wear. Replace if wear is present.
- Fill with grease in order to make the throttle & brake pedal swing more flexibly before installation.

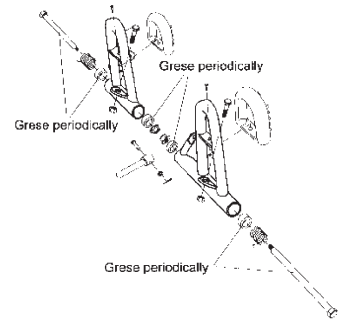

A-ARMS

- Grease the grease fittings of upper & lower A-arm, FR. wheel periodically
- Remove bolt of upper & lower A-arm, FR. wheel
- Check the nylon bushing of upper & lower A-arm, FR. wheel for wear. Replace immediately if wear is present.

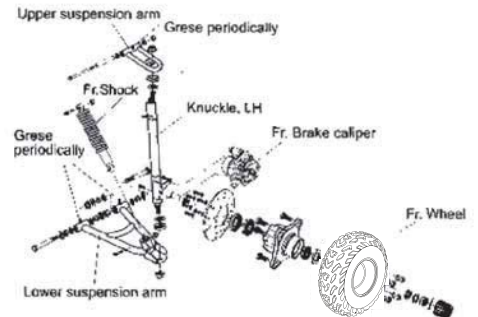

STEERING KNUCKLE SUPPORT

- Remove rubber dust cover of the knuckle support.
- Check the grease of ball joint. Clean it if it is dirty and filled with grease.
- Replace the steering knuckle support if the ball joint is loose or steering isn't flexible.

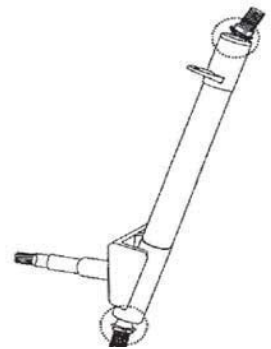

TIE ROD

Tie rods should be checked for ease of movement in their full rotation.

- Remove protective boot and apply grease.
- Check tie rod ends periodically for tightness at their adjusting nuts.
- Always use a new cotter pin after removal.

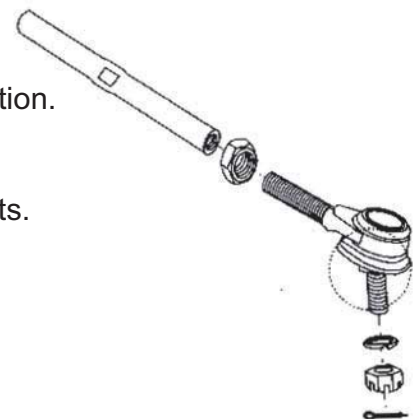

REVERSE ADJUSTMENT

1. Press down the reverse lever to the "FW" position so that the units can move forward. Pull back the level to "BW" so that the units can move backward.
2. In the forward position there should be about 1/4 inch play in the cable for the correct adjustment. If adjustment is required, use adjusting nut on top of the reverse gear box.

SERVICE AIR CLEANER

Service pre-cleaner every 100 hours.

NOTE: service more often under dusty conditions.

- Remove cleaner cover.
- Remove air cleaner.

Element 2, 3.

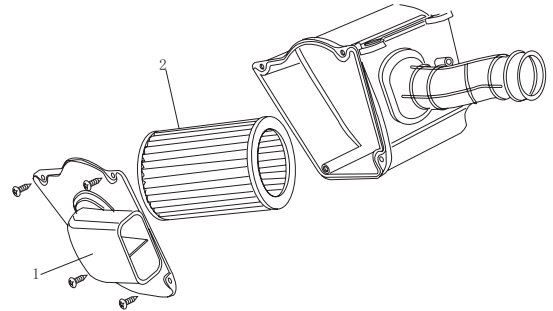

TO SERVICE PRE-CLEANER

- Clean foam filter with non-flammable cleaner.
- If filter is made of paper, tap filter on an object, knocking dust from filter; or replace with new filter.
- Dry filter after cleaning. Then dip it into engine oil specified by the manufacturer, and ring excess oil out of filter.

SPARK PLUG

- Remove the spark plug and inspect it each time you change the oil. (Use a sparkplug wrench). The electrodes should be kept clean and free of carbon. The presence of carbon or excess oil will greatly deter proper engine performance. If possible, check the spark plug gap (area between electrodes) using a wire feeler gauge. This specification is 0.025" ~ 0.030".
- Before installing spark plug coat threads lightly with graphite grease if possible, to ensure easy removal in the future.
- It is advisable to replace the spark plug at least once a year to insure easy starting and good engine performance.

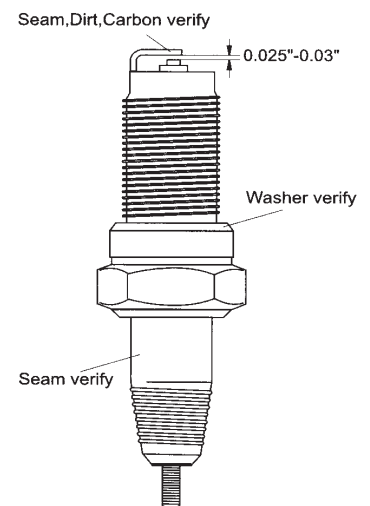

FRONT WHEEL ALIGNMENT

- The front wheel should be "toed-in" from 1/8" to 1/4". To check alignment measure distance from A to B to the centerline (CL) of the tires with the wheels pointed straight ahead. For the proper toe-in dimension, A should be 1/8" ~ 1/4" greater than dimension B.

- Loosen the lock nuts on both sides of front tie rods. To make Dimension B smaller, screw the rod left. If B needs to be longer, turn the rod to the right. Tighten the jam nut tightly against the rod end. Recheck the distance and repeat the above steps until the dimensions are per paragraph 1 above.

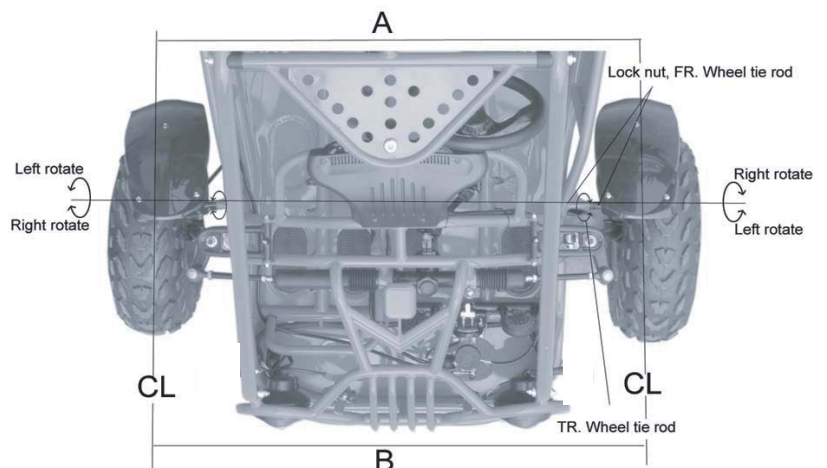

CHAIN TENSIONER ADJUSTMENT

After the first two hours of operation, check the chain adjustment, and readjust if it has more than 1/2" flex.

1. Loosen Nut 1
2. Adjust Nut 2 (Turn nut clockwise in 1/2 turn increments, then turn nut#1 clockwise until nut is tight. Follow this procedure until chain is at proper tension.)

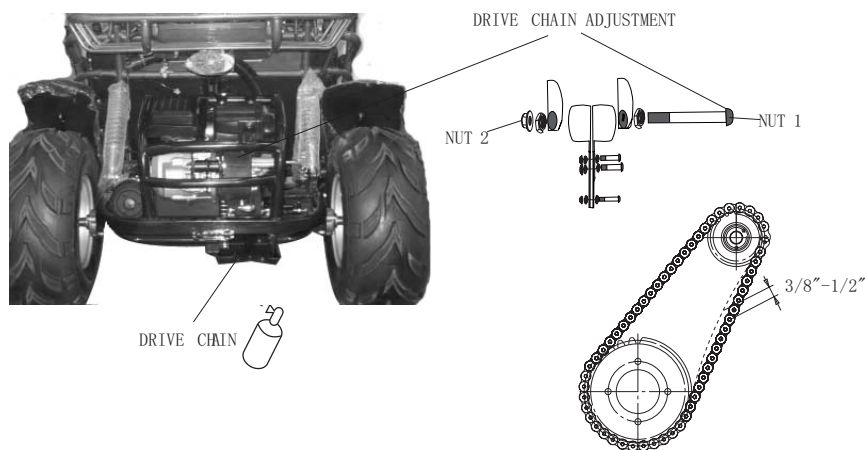

REVERSE GEAR CHECK

- Check internal parts of Reverse Comp. periodically for parts wear, replace them if wear is present. Clean if dirty and re-grease using a liberal amount.

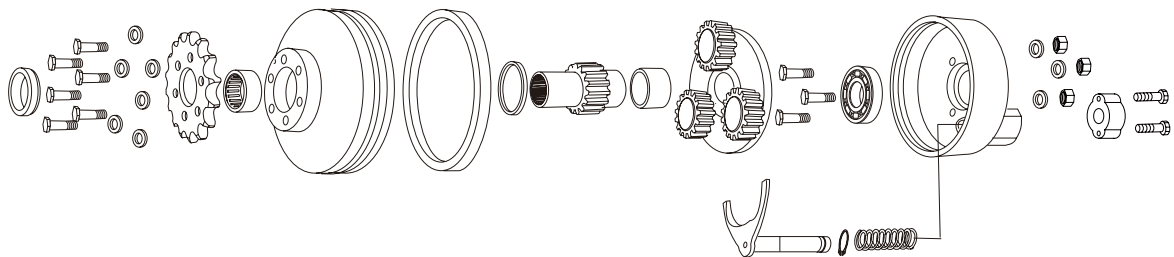

WIRING DIAGRAM

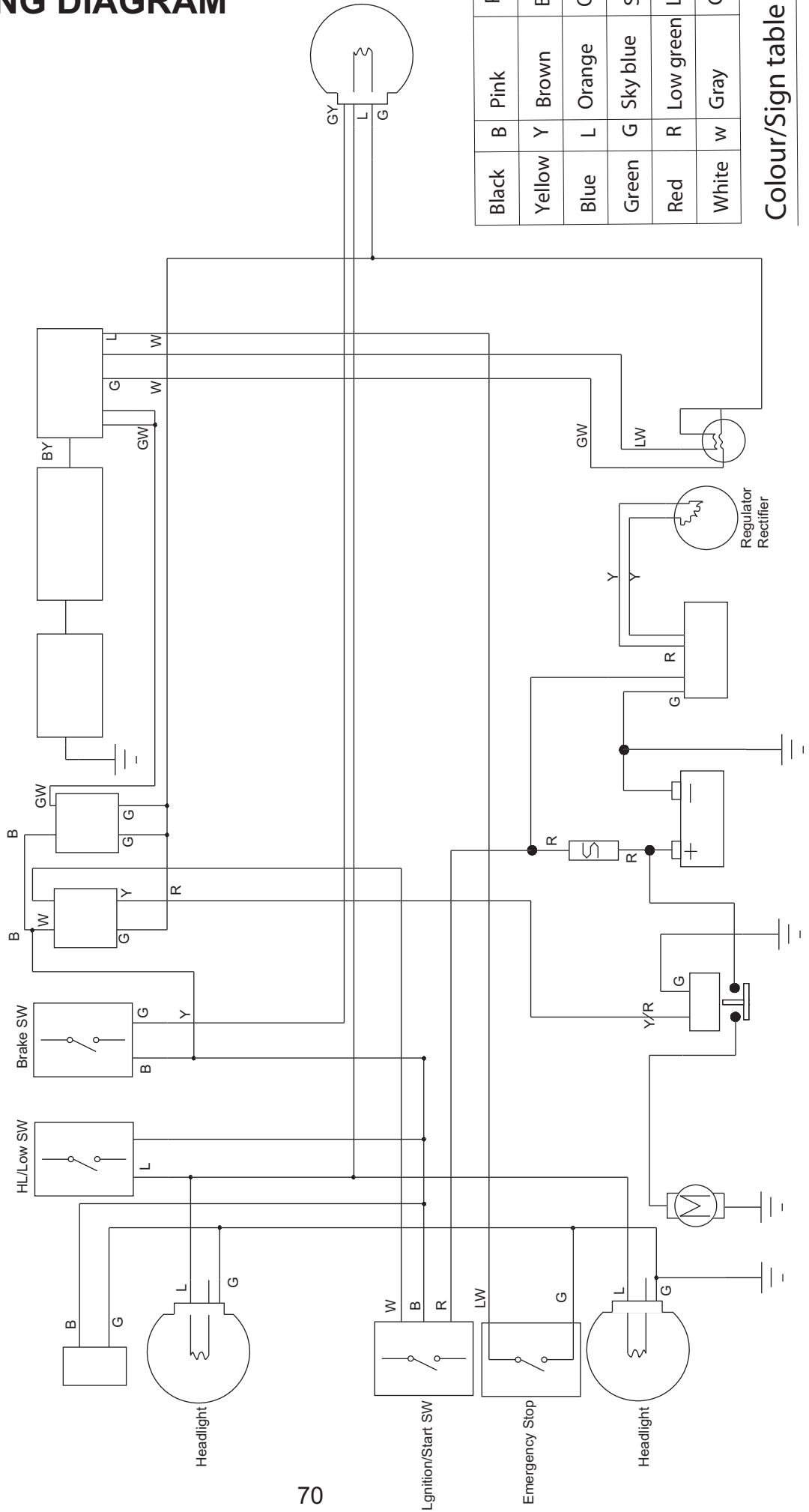

Black	B	Pink	P
Yellow	Y	Brown	BR
Blue	L	Orange	O
Green	G	Sky blue	SB
Red	R	Low green	LG
White	w	Gray	GR

Colour/Sign table

INDEX

A-ARMS	67
ADJUSTMENT OF FRONT & REAR SHOCK	65
AIR ADJUSTING SCREW ADJUSTMENT	29
AIR CHECK VALVE	32
AIR CHECK VALVE INSTALLATION	32
AIR CLEANER	6
AIR CUT VALVE INSTALLATION	32
AIR CUT VALVE REMOVAL	32
AIR CUT VALVE(ACV)	32
ARMATURE INSPECTION	35
AUTOMATIC SIDE STARTER INSPECTION	30
AUTOMATIC SIDE STARTER(CHOKE)	30
BATTERY	55
BATTERY CHARGING	56
BATTERY INSTALLATION	55
BATTERY OPEN-CIRCUIT VOLTAGE INSPECTION	55
BATTERY REMOVAL	55
BEARING ON THE LEFT CRANKCASE BODY REPLACEMENT	51
BELT DRIVEN CVT MECHANISM INSPECTION AND SERVICING	40
BRAKE PERFORMANCE	6
BREAK-IN PROCEDURE	1
CAM CHAIN TENSIONER	18
CAMSHAFT	16
CAMSHAFT INSPECTION	16
CAMSHAFT INSTALLATION	17
CAMSHAFT REMOVAL	16
CAPACITIES	2
CARBON BRUSH INSPECTION	35
CARBURETOR	8
CARBURETOR IDLING ADJUSTMENT	29
CARBURETOR INSTALLATION	31
CARBURETOR INSTALLATION	31
CDI COMPONENT	62
CDI COMPONENT	62
CHAIN TENSIONER ADJUSTMENT	69
CHARGING STATUS INSPECTION	54
CHARGING SYSTEM INSPECTION AND SERVICING	54
CHASSIS	2
CHASSIS	8
CHASSIS	64
CHASSIS NUTS AND BOLTS	7
CLUTCH	44

CLUTCH DISASSEMBLING	44
CLUTCH INSPECTION	44
CLUTCH INSTALLATION	45
CLUTCH REMOVAL	44
CONNECTING ROD END INSPECTION	10
CONTROLLING MECHANISM	39
CRANK CONNECTION ROD MECHANISM:PISTON SET	10
CRANK CONNECTION ROD SET	11
CRANKCASE AND CRANKSHAFT REMOVAL	11
CRANKSHAFT AND CRANKCASE INSPECTION	13
CRANKSHAFT AND CRANKCASE INSTALLATION	13
CV CARBURETOR	28
CYLINDER INNER WALL WEAR INSPECTION	9
CYLINDER REMOVAL	9
DIMENSIONS	2
DRIVE BELT PULLEY	41
DRIVE BELT PULLEY INSPECTION	42
DRIVE BELT PULLEY INSTALLATION	42
DRIVE BELT PULLEY REMOVAL	42
DRIVEN BELT PULLEY	46
DRIVEN BELT PULLEY INSTALLATION	48
DRIVEN PLATE BEARING REPLACEMENT	47
ELECTRIC LEAKAGE TESTING	54
ELECTRICAL STARTING SYSTEM	34
ELECTRICAL SYSTEM	54
ENGAGING MECHANISM	38
ENGINE	2
ENGINE	9
ENGINE COMPONENTS:CYLINDER	9
ENGINE NUMBER	1
ENGINE OIL	1
ENGINE OIL	8
FINAL GEAR OIL	8
FLOAT CHAMBER	30
FLOAT CHAMBER INSTALLATION	31
FLOAT CHAMBER INSTALLATION	31
FLOAT CHAMBER REMOVAL	30
FOAM FILTER MAINTENANCE	6
FRAME NUMBER	1
FRONT & REAR SHOCKS	65
FRONT HUBS	66
FRONT WHEEL ALIGNMENT	68
FRONT WHEEL REPLACEMENT	65
FUEL	1

REDUCTION MECHANISM	37
REGULATE RECTIFIER	58
REGULATE RECTIFIER INSPECTION	59
REMOVE THE CDI COMPONENT	62
RESISTOR	59
RESISTOR RESISTANCE VALUE MEASUREMENT	59
REVERSE ADJUSTMENT	67
REVERSE GEAR CHECK	69
ROCKER ARM AND ROCKSHAFT	17
ROCKER ARM AND ROCKSHAFT INSPECTION	17
ROCKER ARM AND ROCKSHAFT INSTALLATION	18
ROCKER ARM AND ROCKSHAFT REMOVAL	17
ROTARY OIL PUMP	25
SEAT	66
SECONDARY IGNITION COIL INSPECTION	63
SERVICE AIR CLEANER	68
SPARK PLUG	5
SPARK PLUG	63
SPARK PLUG	69
SPECIFICATIONS	1
SPIRAL SPLINE TRANSFERRING STYLE STARTING MECHANISM	33
STARTER MOTOR	34
STARTER MOTOR INSTALLATION	36
STARTER MOTOR REMOVAL	34
STARTER RELAY INSPECTION	39
STARTING CLUTCH INSPECTION	38
STARTING CLUTCH INSTALLATION	39
STARTING CLUTCH REMOVAL	38
STARTING MECHANISM INSPECTION AND SERVICING	33
STEERING GEAR BOX AND BALL HEAD AND STEERING GEAR BOX	66
STEERING KNUCKLE SUPPORT	67
STEERING SHAFT	66
THROTTLE & BRAKE REDAL	67
TIR ROD	67
TIRE PRESSURE	3
TIRE PRESSURE/WEAR	6
TO CLEAN CARBON ACCUMULATION OFF THE VALVE GUIDE	20
TO SERVICE PRE-CLEANER	68
TORQUE TIGHTENING CHART	7
TRANSMISSION BELT	48
TRANSMISSION BELT INSPECTION	48
TRANSMISSION CASE	50
TRANSMISSION CASE GEAR INSPECTION	50
TRANSMISSION CASE OIL INSPECTION	49

FUEL AND OIL RECOMMENDATIONS	1
FUEL LEVEL INSPECTION	31
FUEL SUPPLY SYSTEM INSPECTION AND SERVICING	28
FUEL SWITCH (PETCOCK)	7
GEARING ON THE TRANSMISSION CASE COVER REPLACEMENT	51
GENERAL INFORMATION	1
GENERAL INTRODUCTION	14
GENERAL INTRODUCTION	24
GENERAL INTRODUCTION	40
GENERATOR INSTALLATION	58
GENERATOR REMOVAL	57
GENERATOR REMOVAL AND INSPECTION	57
IGNITION CHARGING COIL	61
IGNITION COIL	63
IGNITION COIL INSTALLATION	63
IGNITION COIL REMOVAL	63
IGNITION SYSTEM INSPECTION	60
IGNITION SYSTEM INSPECTION AND SERVICING	60
IGNITION TIME INSPECTION	60
LOCATION OF PARTS	4
LUBRICATION SYSTEM INSPECTION AND SERVICING	24
MAIN WIRING-SUB ELECTRIC CIRCUIT CONDITION INSPECTION	58
MAINTENANCE AND TUNE-UP PROCEDURES	5
MODEL IDENTIFICATION	1
OIL PUMP ASSEMBLING	27
OIL PUMP INSPECTION	26
OIL PUMP INSTALLATION	27
OIL PUMP REMOVAL	25
OIL REPLACEMENT	25
OIL SYSTEM INSPECTION AND REPLACEMENT	25
PAPER FILTER MAINTENANCE	6
PERIODIC MAINTENANCE AND TUNE-UP PROCEDURES	5
PERIODICAL CHECK AND SERVICES	5
PISTON PIN INSPECTION AND SERVICING	10
PISTON RINGS INSPECTION AND SERVICING	10
PISTON RINSS SET UP	11
PISTON SET INSTALLATION	11
PRIMARY COIL	56
PRIMARY COIL INSPECTION	57
PRIMARY IGNITION COIL INSPECTION	63
REAR AXLE REMOVAL	64
REAR SWINGARM	64
REAR TRANSMISSION MECHANISM INSPECTION AND SERVICING	49
REDUCTION GEAR INSPECTION	37

TRANSMISSION CASE OIL REPLACEMENT	49
TRANSMISSION CASE REMOVAL	50
TRANSMISSION COMPONENTS	33
TRANSMISSION CASE OIL REPLACEMENT	49
TRIGGER WINDING	62
VACUUM CHAMBER	29
VACUUM CHAMBER INSTALLATION	30
VACUUM CHAMBER REMOVAL	29
VALVE AND VALVE SEAT AIR IMPERMEABILITY INSPECTION	23
VALVE AND VALVE SEAT LAPPING	23
VALVE AND VALVE SPRING	19
VALVE AND VALVE SPRING INSPECTION	19
VALVE AND VALVE SPRING INSTALLATION	19
VALVE AND VALVE SPRING REMOVAL	19
VALVE CLEARANCE	8
VALVE CLEARANCE ADJUSTMENT	15
VALVE GUIDE	20
VALVE GUIDE INNER DIAMETER MEASUREMENT	20
VALVE GUIDE REPLACEMENT	20
VALVE MECHANISM INSPECTION AND SERVICING	14
VALVE SEAT	21
VALVE SEAT FINISHING	21
VALVE SEAT TOUCHING POSITION INSPECTION	22
VALVE SEAT WIDTH MEASUREMENT	21
WARRANTY	3
WEIGHT	3
WIRING DIAGRAM	70